

Fontini

BY

Font
BARCELONA



Fontini

Empresa familiar,
fabricantes desde 1950

Family company,
manufacturer since 1950

Société familiale,
fabricants depuis 1950

En 1950, Joan Font González, fundó una pequeña fábrica de material eléctrico en la provincia de Barcelona. Hoy, su legado sigue presente en Fontini, donde la familia Font sigue pilotando ese sueño, liderando el sector del material eléctrico decorativo alrededor del mundo.

GARBY, 20 AÑOS JUNTOS. Esta trayectoria, nos lleva a celebrar el 20º aniversario de una de nuestras series más icónicas, la serie GARBY. 20 años de tradición concentrados en la serie retro más reconocida a nivel internacional.

In 1950 Joan Font González founded a small electrical supply factory in Barcelona area. Today his heritage is still present with the Font family taking relay on his dream: make Fontini the leader on decorative switches and sockets in the world.

GARBY 20 YEARS TOGETHER. Our history takes us to celebrate 20th Anniversary of our iconic and emblematic collection: Garby. 20 years of traditions and know-how to manufacture the most famous retro switch in the world.

En 1950, Joan Font González fonde une petite usine de fabrication de matériel électrique dans la région de Barcelone. Aujourd'hui, son héritage est toujours vivant au sein de Fontini, la famille Font est encore présente pour faire perdurer son rêve, faire de la marque le leader des appareillages décoratifs dans le monde.

GARBY 20 ANS ENSEMBLES. Notre trajectoire nous amène à célébrer le 20º anniversaire de notre collection la plus iconique et emblématique Garby. 20 ans de traditions et de savoir faire pour fabriquer la collection rétro la plus reconnue dans le monde.





FABRICACIÓN ARTESANAL. En un mundo global y dominado por los productos fabricados en masa, en Fontini continuamos fieles a nuestra esencia, intentando transmitir alma y carácter a nuestros productos mediante un proceso de fabricación artesanal. El resultado es una completa gama de productos de gran calidad y diseño, adecuados a las normativas y necesidades actuales.

INTERNACIONALES. Desde los inicios, Fontini ha estado orientado al mercado internacional y hoy podemos decir que estamos presentes en más de 50 países, con una extensa red de distribuidores que forman parte de nuestra familia.

Una familia formada por profesionales que ama los valores del proyecto y nuestro producto.

HAND-MADE MANUFACTURING. In a global world dominated by mass-produced products, at Fontini we remain faithful to our essence, trying to transmit soul and character to our products through a process of artisanal manufacturing. The result is a complete range of products of great quality and design, adapted to current regulations and needs.

INTERNATIONAL. From the beginning, Fontini has been oriented to the international market and today we can say that we are present in more than 50 countries, with an extensive network of distributors that are part of our family.

A family formed by professionals who love the values of the project and our product.

FABRICATION ARTISANALE. Dans une société de consommation globale où les produits sont fabriqués à la chaîne, nous sommes fidèles à notre esprit en fabricant nos collections de façon manuelle et artisanale pour donner une âme à nos collections. Le résultat est une gamme complète d'excellente qualité au design « vintage » avec toutes les normes et exigences actuelles.

INTERNATIONAL. Depuis ses débuts Fontini s'est toujours orienté vers les marchés internationaux et nous sommes, aujourd'hui, présents dans plus de 50 pays avec un grand réseau de distribution qui est pour nous l'extension de la famille.

Une famille formée par des professionnels qui aiment les valeurs du projet et de notre produit.

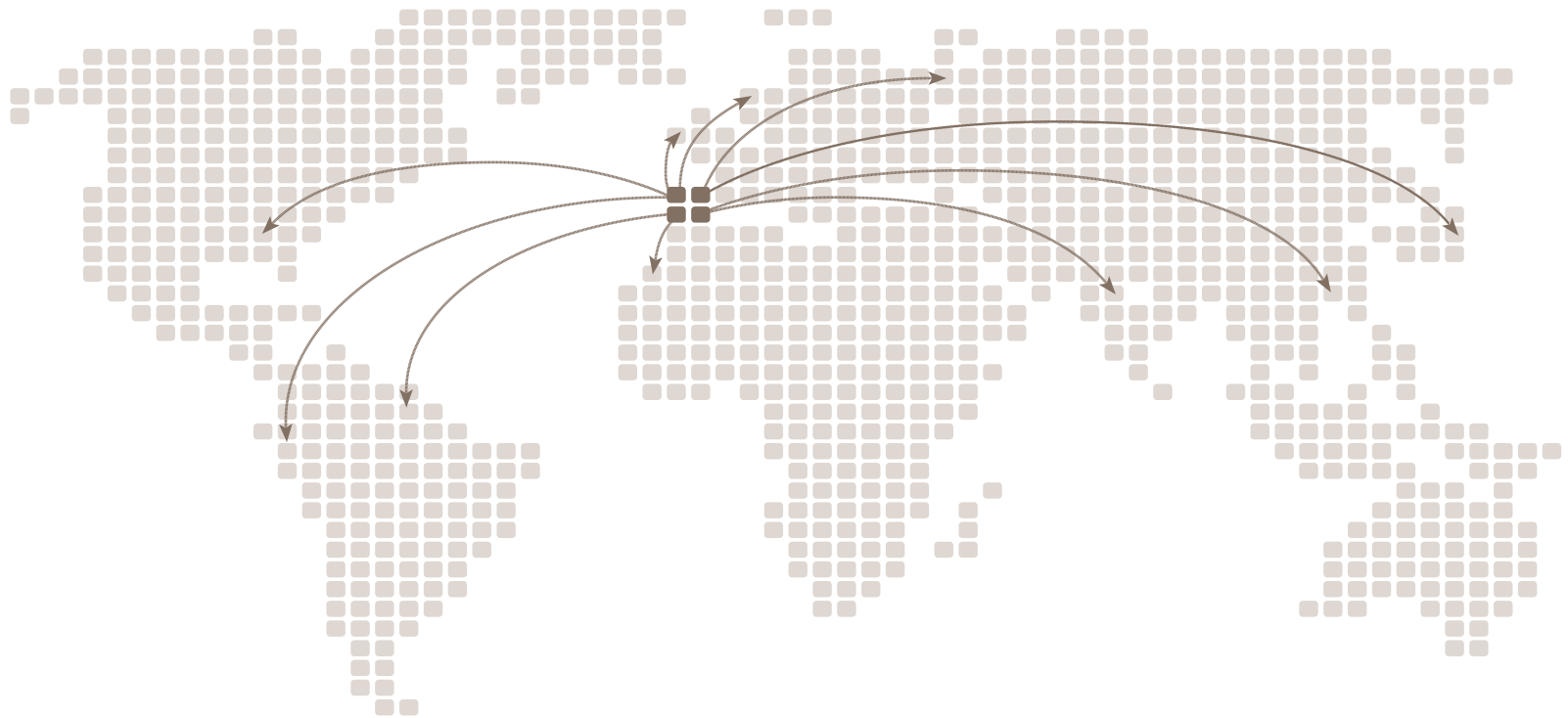



reddot design award
winner 2016



LICENCE

NF LICENCE N°: 65021

Diffusé à :
Détenteur(s) : **FONTEI S.A.**
19130 SANTA PERPETUA DE MOGODA (BARCELONA) - ESPAGNE

Site de fabrication :
Factory : **FONTEI S.A.**
19130 SANTA PERPETUA DE MOGODA (BARCELONA) - ESPAGNE

Produit :
Product : **Interrupteur**
Marsch commerciale (S'Y y a line) : **16 A, 250 V~**

Modèle, type, référence :
Model, type, reference : **16 A, 250 V~ 2P+T / 2P+E**

Caractéristiques techniques et principales :
Rating and principal characteristics : **16 A, 250 V~ 2P+T / 2P+E**

Informations complémentaires :
Additional information : **voir annex / see annex**

La présente licence est valide :
This product is in conformity with : **NF C 61-14:2008 +A1:2010**

Documents joints en compte :
Attached documents : **Rapport dossier / Test reports LDE n°128532483534**

Annexes et remplages (S'Y y a line) :
Accessories and replacers (if necessary) : **Licence n°60048973 du 2007-06-20**

Enquiry-consultation : 2014-04-01

Date de fin de validité :
Valid until : **2022-05-20**

Le titulaire de la présente licence autorise tout détenteur de la licence à utiliser son matériel sous réserve de respecter les conditions de validité de la licence.

On the strength of the present license issued by VDE France, recipient authorizes every holder of the license to use his material under the terms of the present license, under the condition that he respects the conditions of validity of the license.

RNAI NAI017
Responsable de Certification
Certification Office

AENOR

Certificado AENOR de Producto
Aparatura eléctrica para baja tensión

AENOR
Producto
Certificado

030/001664

AENOR certifica que la composición
FONTEI, S.A.

(con domicilio social en) **EL ANOIA, 15 08130 STA. PERPETUA DE LA MOGODA (Barcelona - España)**

conforma con los normos
UNE-EN 60669-1:2005 (EN 60669-1:1999/A1:2002)
UNE-EN 60669-1:2002 (EN 60669-1:1999)
CORR:2007
UNE-EN 60669-1:2002/A1:2009 (EN 60669-1:1999/A1:2003)

Referencia: **Detallados en el Certificado**

Centro de producción: **EL ANOIA, 15 08130 STA. PERPETUA DE LA MOGODA (Barcelona - España)**

Exigencia de certificación: **Para poder utilizar este Certificado, AENOR ha inspeccionado el producto y ha comprobado el sistema de la calidad utilizado para su fabricación. AENOR realiza estas actividades periódicamente en virtud de su Certificado de Acreditación, según se establece en el Reglamento Europeo RP 7011.**

Fecha de última revisión: **2022-05-20**

Fecha de expiración: **2022-05-20**

Antonio BERRIO NAVARRO
Director General

AENOR INTERNACIONAL S.L.
C/Alfonso de Ercilla, 16 28014 Madrid, España
Tel: +34 91 63 64 00 - www.aenor.es

VDE Prüf- und Zertifizierungsinstitut

ZEICHENGENEHMIGUNG
MARKS APPROVAL

FONTEI S.A.
C/ Anòia num. 15
Pol. Industrial Can Bernades-Subirà
08130 SANTA PERPETUA DE LA MOGODA
SPAIN

ist bescheinigt, für ein Produkt /
is authorized to use for their product
Installationschalter
Installation switch

ist für abgebildetes markenrechtlich geschütztes Zeichen
für die ab Bild 2. abgebildeten Typen zu benutzen /
The legally protected Marks as shown below for the types referred to on page 2 of

DVE

Geprüft und zertifiziert nach /
Tested and certified according to

EN 60669-1:2005 (EN 60669-1:1999 + A1:2002) / A2:2010

VDE

VDE Prüf- und Zertifizierungsinstitut GmbH
VDE Testing and Certification Institute
Zertifizierungsstelle / Certification

Altenbachstr. 11
40476 Essen, Germany
Tel: +49 201 4703-0
Fax: +49 201 4703-200
www.vde.com

Altenbachstr. 11
40476 Essen, Germany
Tel: +49 201 4703-0
Fax: +49 201 4703-200
www.vde.com

2013-03-05
(Date, Amendment/Update 2013-03-21)

VDE Prüf- und Zertifizierungsinstitut
VDE certification are valid only when published on

Colecciones de superficie / Surface installation collections / Collections pour installation en saillie

9



DO
9



GARBY
29



DIMBLER
59

Colecciones de empotrar / Fitting installation collections / Collections pour installation encastrée

71



DO
71



GARBY COLONIAL
93



VENEZIA
119



F37
149



Información técnica / Technical information / Information technique

175

DO
Collection

Fontini
BY
Font
DESIGN



SUPERFICIE SURFACE SAILLIE

DO Collection

Manecillas y tornillos / Knobs and screws / Manettes et vis (pg. 14)

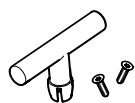

Mecanismos / Mechanisms / Mécanismes (pg. 15)

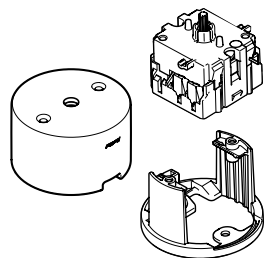

Marcos / Frames / Plaques (pg. 24)

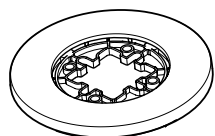

Peanas / Bases / Socles (pg. 26)

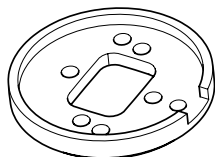

-
- Instalación de superficie
 - Mecanismos de 10AX 250V~
 - Bases de enchufe de 16A 250V~
 - Contactos de plata de alto poder de ruptura
 - Construida con porcelana y termoplásticos técnicos
 - Marcos de madera y porcelana
 - Marcos para instalar en posición vertical u horizontal y para caja universal

-
- Surface installation
 - 10AX 250V~ mechanisms
 - 16A 250V~ sockets
 - Silver contacts with high breaking power
 - Manufactured with porcelain and technical thermoplastic materials
 - Wood and porcelain frames
 - Frames for vertical or horizontal installations and for fitted in universal boxes

-
- Installation en saillie
 - Mécanismes de 10AX 250V~
 - Prises de courant 16A 250V~
 - Contacts en argent avec haut pouvoir de rupture
 - Fabriqués en porcelaine et a partir de techniques thermoplastiques
 - Plaques en bois et porcelaine
 - Plaques pour installation horizontale ou verticale en saillie dans boîtiers universel
-

DO
Collection



SERIE 33
Acabados / Finishes / Finitions



17

Porcelana blanca
White porcelain
Porcelaine blanche



27

Porcelana negra
Black porcelain
Porcelaine noire



11

Botón/tornillos metal cromo
Chrome-colour metal button/screws
Bouton/vis métal chrome



01



12

Botón/tornillos metal níquel negro
Black nickel button/screws
Bouton/vis métal nickel noir



02



13

Botón/tornillos metal cobre brillo
Polished copper-colour metal button/screws
Bouton/vis métal cuivre brillant



03

Manecilla rotativa metal cromo
Chrome-colour metal rotary knob
Manette rotative métal chrome



+ tornillos cromo
+ chrome screws
+ vis chromées



Pack 1 ud.

33

967

26

1

Pack 5 uds.

33

967

26

7

Manecilla rotativa metal níquel negro
Black nickel metal rotary knob
Manette rotative métal nickel noire



+ tornillos níquel negro
+ black nickel screws
+ vis nickel noire



Pack 1 ud.

33

967

30

1

Pack 5 uds.

33

967

30

7

Manecilla rotativa metal cobre brillo
Polished copper-colour metal rotary knob
Manette rotative métal cuivre brillant



+ tornillos cobre
+ copper screws
+ vis cuivre



Pack 1 ud.

33

967

31

1

Pack 5 uds.

33

967

31

7



SERIE 33

Mecanismos / Mechanisms / Mécanismes

Serie
Series
Série

Función
Function
Fonction

Ver acabados
See finishes
Voir finitions

Código
Code
Code



Interruptor unipolar- Conmutador
Single pole switch - Two-way switch
Interrupteur unipolaire- Va-et-vient

10AX - 250V~

33 308 -- 1

Cruzamiento
Intermediate switch
Permutateur

10AX - 250V~

33 304 -- 1

Interruptor bipolar
Double pole switch
Interrupteur bipolaire

10AX - 250V~

33 314 -- 1

Mecanismo para persianas (para motores de 1,66A)
Electric blinds mechanism (for 1.66A motors)
Mécanisme pour volets roulants (pour moteurs 1,66A)

10A - 250V~

33 342 -- 1

Doble interruptor - Conmutador
Double single pole - Two way switch
Double interrupteur - Va-et-vient

10AX - 250V~

33 302 -- 1

Acabados
Finishes
Finitions

17



27





Pulsador rotativo
Rotary pushbutton switch
Poussoir rotatif

10AX - 250V~

Posición de reposo
Rest position
Position de repos

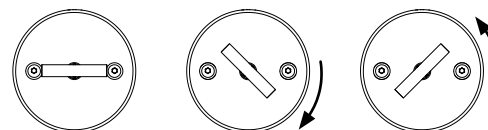

SALIDA / OUTPUT / SORTIE

OFF

ON

ON

33

328

--

1

Doble pulsador rotativo
Double rotary pushbutton switch
Double poussoir rotatif

10AX - 250V~

Posición de reposo
Rest position
Position de repos

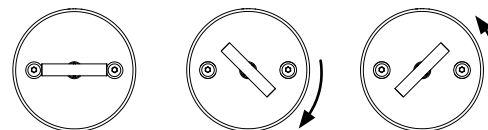

SALIDA / OUTPUT / SORTIE

OFF

ON 1

ON 2

33

344

--

1



Serie
Series
Série

Función
Function
Fonction

Ver acabados
See finishes
Voir finitions

Código
Code
Code



Pulsador
Pushbutton
Bouton poussoir

10AX - 250V~

33

310

--

2



Acabados
Finishes
Finitions

11



12



13



01





02



03



	<p>Base de enchufe bipolar con tomatierra lateral Two-pole socket-outlet with side earth contact Prise de courant avec contact latéral de terre</p>	<p>16A - 250V~</p>	<table border="1"> <tbody> <tr> <td data-bbox="1541 430 1680 478">33</td> <td data-bbox="1680 430 1836 478">212</td> <td data-bbox="1836 430 1993 478">--</td> <td data-bbox="1993 430 2134 478">2</td> </tr> </tbody> </table>				33	212	--	2
33	212	--	2							
	<p>Base de enchufe bipolar francesa con espiga de contacto de tierra French two-pole socket-outlet with earth pin Prise de courant système français avec terre</p>	<p>16A - 250V~</p>	<table border="1"> <tbody> <tr> <td data-bbox="1541 813 1680 861">33</td> <td data-bbox="1680 813 1836 861">208</td> <td data-bbox="1836 813 1993 861">--</td> <td data-bbox="1993 813 2134 861">2</td> </tr> </tbody> </table>				33	208	--	2
33	208	--	2							

SERIE 33

Reguladores de luz / Dimmers / Variateurs

Serie
Series
Série

Función
Function
Fonction

Ver acabados
See finishes
Voir finitions

Código
Code
Code

Mecanismo + regulador / Mechanism + dimmer / Mécanisme + variateur



Regulador rotativo pulsación
Rotary pushbutton dimmer
Régulateur rotatif pulsation

Incandescencia - halógenas 230V~ 40-500W
Incandescent - halogen bulbs 230V~ 40-500W
Incandescence - halogènes 230V~ 40-500W

Transformador mecánico 40-500W
Mechanical transformer 40-500W
Transformateur mécanique 40-500W

33 333 -- 1

Incandescencia - halógenas 230V~ 60-900W
Incandescent - halogen bulbs 230V~ 60-900W
Incandescence - halogènes 230V~ 60-900W

Transformador mecánico 60-900W
Mechanical transformer 60-900W
Transformateur mécanique 60-900W

33 334 -- 1

LED 1 - 200W

33 3K8 -- 1

LED 1-100W

Incandescencia - halógenas 230V~ 1-400W
Incandescent - halogen bulbs 230V~ 1-400W
Incandescence-halogènes 230V~ 1-400W

Transformador electrónico-electromecánico 1-300W
Electronic-electromechanical transformer 1-300W
Transformateur électronique-électromécanique 1-300W

33 3K9 -- 1

Lámparas fluorescentes compactas (CFL) 1-100W
Compact fluorescent lamps (CFL) 1-100W
Lampes fluorescentes compactes (CFL) 1-100W

0-10V / 1-10V máx. 50mA

33 3L0 -- 1



Los reguladores de pulsación disponen de un dispositivo electrónico que debe ser instalado en una caja anexa al pulsador.

Pushbutton dimmers are fitted with an electronic device that must be installed in a box attached to the pushbutton.

Les variateurs à poussoir sont dotés d'un dispositif électronique qui doit être installé dans un boîtier annexe.

Acabados
Finishes
Finitions

17



27



Mecanismo + regulador / Mechanism + dimmer / Mécanisme + variateur



Regulador pulsación botón
Pushbutton dimmer
Régulateur pulsation bouton

Incandescencia - halógenas 230V~ 40-500W
Incandescent - halogen bulbs 230V~ 40-500W
Incandescence - halogènes 230V~ 40-500W

Transformador mecánico 40-500W
Mechanical transformer 40-500W
Transformateur mécanique 40-500W

33 358 -- 2

Incandescencia - halógenas 230V~ 60-900W
Incandescent - halogen bulbs 230V~ 60-900W
Incandescence - halogènes 230V~ 60-900W

Transformador mecánico 60-900W
Mechanical transformer 60-900W
Transformateur mécanique 60-900W

33 359 -- 2

LED 1 - 200W

33 3L4 -- 2

LED 1-100W

Incandescencia - halógenas 230V~ 1-400W
Incandescent - halogen bulbs 230V~ 1-400W
Incandescence-halogènes 230V~ 1-400W

Transformador electrónico-electromecánico 1-300W
Electronic-electromechanical transformer 1-300W
Transformateur électronique-électromécanique 1-300W

33 3L5 -- 2

Lámparas fluorescentes compactas (CFL) 1-100W
Compact fluorescent lamps (CFL) 1-100W
Lampes fluorescentes compactes (CFL) 1-100W

0-10V / 1-10V máx. 50mA

33 3L6 -- 2



Los reguladores de pulsación disponen de un dispositivo electrónico que debe ser instalado en una caja anexa al pulsador.

Pushbutton dimmers are fitted with an electronic device that must be installed in a box attached to the pushbutton.

Les variateurs à poussoir sont dotés d'un dispositif électronique qui doit être installé dans un boîtier annexe.

Acabados
Finishes
Finitions

11



12



13



01



02



03



SERIE 33

Tomas de televisión / Television sockets / Prises télévision

Serie
Series
Série

Función
Function
Fonction

Ver acabados
See finishes
Voir finitions

Código
Code
Code



Toma señal RTV-SAT ecualizada
R/TV and SAT equalized signal socket
Prise signal RTV-SAT égalisée

Toma única
Single socket
Prise unique

33

712

--

2

Toma intermedia
Intermediate socket
Prise intermédiaire
A

33

713

--

2

Toma intermedia
Intermediate socket
Prise intermédiaire
B

33

714

--

2

Toma final
Final socket
Prise finale

33

711

--

2



Ver información técnica en: See technical information on: Voir informations techniques: **Pg. 190**

Acabados
Finishes
Finitions

17



27





Doble toma
Double socket
Double prise

Telefonía 6 vías
Telephone 6 ways
Téléphone 6 voies

33

706

--

2

RJ45 CAT6

33

707

--

2

6 vías + RJ45 CAT6

33

708

--

2



Doble toma
Double socket
Double prise

RJ45 CAT6A
apantallado
shielded
blindé

33

761

--

2



SERIE 33

Otras funciones / Other functions / Autres fonctions

Serie
Series
Série

Función
Function
Fonction

Ver acabados
See finishes
Voir finitions

Código
Code
Code



Tapa ciega
Blind cover
Couvercle aveugle

33	656	--	2
----	-----	----	---



Salida de cables
Cable outlet cover
Sortie de câbles

Ø 8mm

33	927	--	2
----	-----	----	---

Acabados
Finishes
Finitions

11



12



13



01



02



03



Porcelana / Porcelain / Porcelaine



Porcelana blanca
White porcelain
Porcelaine blanche

Porcelana negra
Black porcelain
Porcelaine noire

	<p>1 elemento 1 element 1 élément</p>	<p>Ø 100x9mm</p>	<p>33 801 17 2</p>	<p>33 801 27 2</p>
	<p>2 elementos 2 elements 2 éléments</p>	<p>171x100x9mm</p>	<p>33 802 17 2</p>	<p>33 802 27 2</p>
	<p>3 elementos 3 elements 3 éléments</p>	<p>243x100x9mm</p>	<p>33 803 17 2</p>	<p>33 803 27 2</p>

Serie	Func.	Acab.	Cod.	Serie	Func.	Acab.	Cod.	Serie	Func.	Acab.	Cod.
Series	Funct.	Finish	Code	Series	Funct.	Finish	Code	Series	Funct.	Finish	Code
Series	Fonct.	Finir.	Code	Series	Fonct.	Finir.	Code	Series	Fonct.	Finir.	Code

Madera / Wood / Bois



Haya oscurecida
Darkened beech
Hêtre obscurci

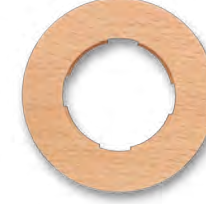

Haya natural
Natural beech
Hêtre naturel

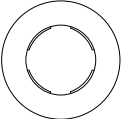
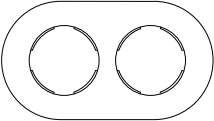
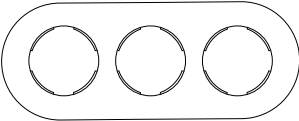

Nogal
Walnut
Noyer

	1 elemento 1 element 1 élément	Ø 100x9mm	33	801	80	2	33	801	81	2	33	801	82	2
	2 elementos 2 elements 2 éléments	171x100x9mm	33	802	80	2	33	802	81	2	33	802	82	2
	3 elementos 3 elements 3 éléments	243x100x9mm	33	803	80	2	33	803	81	2	33	803	82	2

Serie	Func.	Acab.	Cod.	Serie	Func.	Acab.	Cod.	Serie	Func.	Acab.	Cod.
Series	Funct.	Finish	Code	Series	Funct.	Finish	Code	Series	Funct.	Finish	Code
Serie	Fonct.	Finit.	Code	Serie	Fonct.	Finit.	Code	Serie	Fonct.	Finit.	Code



**NO APTO PARA INSTALACIÓN
SOBRE CAJA DE EMPOTRAR UNIVERSAL**

**NOT SUITABLE FOR INSTALLATION
ON UNIVERSAL FLUSH-MOUNTED BOX**

**NE CONVIENT PAS À L'INSTALLATION
SUR BOÎTE UNIVERSELLE ENCASTRABLE**



Haya oscurecida
Darkened beech
Hêtre obscurci

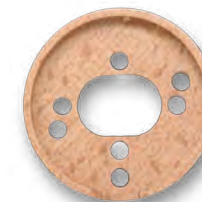

Haya natural
Natural beech
Hêtre naturel







Nogal
Walnut
Noyer

	1 elemento 1 element 1 élément	Ø 64x9mm	33	811	80	2	33	811	81	2	33	811	82	2
	2 elementos 2 elements 2 éléments	136x65x21mm	33	812	80	2	33	812	81	2	33	812	82	2
	3 elementos 3 elements 3 éléments	207x65x21mm	33	813	80	2	33	813	81	2	33	813	82	2

SERIE 33

Accesorios / Accessories / Accessoires

Serie Series Série	Función Function Fonction	Acabado Finish Finition	Código Code Code
--------------------------	---------------------------------	-------------------------------	------------------------

	Caja de empalmes Junction box Boîtier de derivation	\varnothing 77mm \updownarrow 46mm	33	399	17	2	
			33	399	27	2	
	Pack abrazadera Bracket pack Pack collier	16mm	Pack 25 uds.	33	816	25	2
	Aislador de porcelana Porcelain insulator Isolateur porcelaine Distancia recomendable entre cada aislador: 40cm Recommended distance between each insulator: 40cm Distance conseillée entre chaque isolaieur: 40 cm	\varnothing 10mm \updownarrow 23mm	Pack 25 uds.	33	913	17	0
				33	913	27	0
	Cable ignífugo. Conductor de PVC blindado con fibra de vidrio 750V. Rollos 25 m. Fireproof wire. Fibreglass screened 750V PVC conductor. Rolls 25 m. Câble ignifuge. Conducteur de PVC blindé avec fibre de verre 750 V. Rouleau 25 m. Según Reglamento Electrotécnico para Baja Tensión (Real Decreto 842/ 2002) con entrada en vigor el 18 de Septiembre de 2003, el cable trenzado PVC de 750V únicamente es apto para reformas o modificaciones de instalaciones existentes que no afecten a más del 50% de la potencia instalada.	2x1,5mm ²	33	989	02	2	
			33	989	05	2	
			33	989	08	2	
		3x1,5mm ²	33	990	02	2	
			33	990	05	2	
			33	990	08	2	
			3x2,5mm ²	33	991	02	2
				33	991	05	2
				33	991	08	2
		4x1,5mm ²	33	992	02	2	
			33	992	05	2	
			33	992	08	2	

 17 Porcelana blanca
 White porcelain
 Porcelaine blanc

 27 Porcelana negra
 Black porcelain
 Porcelaine noire

 02 Negro
 Black
 Noir

 05 Blanco
 White
 Blanc

 08 Marsala
 Marsala
 Marsala

GARBY
Collection

Fontini
BY
Font
DESIGN



GARBY

Collection

Manecillas y tornillos / Knobs and screws / Manettes et vis (pg. 36)

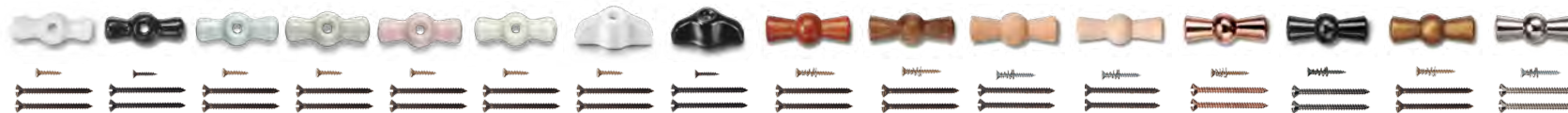
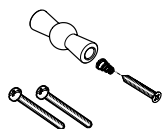

Mecanismos / Mechanisms / Mécanismes (pg. 38)

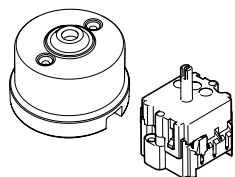

Opcional / Optional / Optionnel Peanas / Bases / Socles (pg. 47)

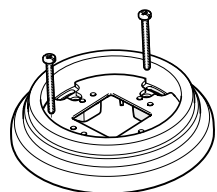

Peanas para tubo / Bases for pipe / Socle pour tube (pg. 48)



Marcos / Frames / Plaques (pg. 51)

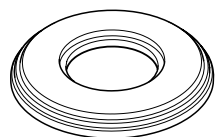

 **LOS MARCOS NECESITAN ADAPTADOR para montar en superficie / FRAMES REQUIRE ADAPTER for surface mounting /**
LES PLAQUES REQUIÈRENT ADAPTATEUR pour un montage en saillie

-
- Instalación de superficie
 - Mecanismos de 10AX 250V~
 - Bases de enchufe de 16A 250V~
 - Contactos de plata de alto poder de ruptura
 - Construida con porcelana y termoplásticos técnicos
 - Marcos y peanas de madera y porcelana
 - Peanas para instalar en posición vertical u horizontal y para caja de empotrar
 - Marcos para instalación en superficie y para instalación en caja universal con tornillos mediante adaptador especial
-

- Surface installation
 - 10AX 250V~ mechanisms
 - 16A 250V~ sockets
 - Silver contacts with high breaking power
 - Manufactured with porcelain and technical thermoplastic materials
 - Wood and porcelain frames and bases
 - Bases for vertical or horizontal installations, fitted in universal boxes
 - Frames for surface installation and fitting in standard box installation with screws and special adaptor
-

- Installation en saillie
 - Mécanismes de 10AX 250V~
 - Prises de courant 16A 250V~
 - Contacts en argent avec haut pouvoir de rupture
 - Fabriqués en porcelaine et a partir de techniques thermoplastiques
 - Plaques et socles en bois et porcelaine
 - Plaques pour installation horizontale ou verticale en saillie dans boîtiers universel
 - Plaques pour installation en saillie et pour installation sur boîte d'encastrement universelle avec vis et adaptateur spécial
-
-

GARBY

Collection



SERIE 30
Acabados / Finishes / Finitions



17

Porcelana blanca
White porcelain
Porcelaine blanche



27

Porcelana negra
Black porcelain
Porcelaine noire



61

Porcelana decor azul/plata
Blue/silver decor porcelain
Porcelaine décor blanche/argent



63

Porcelana decor marrón/oro
Brown/gold decor porcelain
Porcelaine décor marron/or



15

Porcelana reggia
Reggia porcelain
Porcelaine reggia

GARBY

Collection



SERIE 30. SPECIAL EDITION
Acabados / Finishes / Finitions

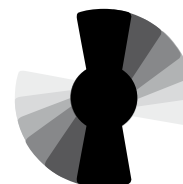

G A R B Y 2 0 Y E A R S



85
Coton



86
Vert ille



































87
Camille



88
Cru

Porcelana / Porcelain / Porcelaine

		Manecilla rotativa porcelana blanca White porcelain rotary knob Manette rotative porcelaine blanche	+ tornillos patiné + patinated screws + vis patinées	Pack 1 ud.	30	967	17	1
				Pack 5 uds.	30	967	17	7
		Manecilla rotativa porcelana negra Black porcelain rotary knob Manette rotative porcelaine noire	+ tornillos negros + black screws + vis noire	Pack 1 ud.	30	967	27	1
				Pack 5 uds.	30	967	27	7
		Manecilla rotativa porcelana Coton Coton porcelain rotary knob Manette rotative porcelaine Coton	+ tornillos patiné + patinated screws + vis patinées	Pack 1 ud.	30	967	85	1
				Pack 5 uds.	30	967	85	7
		Manecilla rotativa porcelana Vert ille Vert ille porcelain rotary knob Manette rotative porcelaine Vert ille	+ tornillos patiné + patinated screws + vis patinées	Pack 1 ud.	30	967	86	1
				Pack 5 uds.	30	967	86	7
		Manecilla rotativa porcelana Camille Camille porcelain rotary knob Manette rotative porcelaine Camille	+ tornillos patiné + patinated screws + vis patinées	Pack 1 ud.	30	967	87	1
				Pack 5 uds.	30	967	87	7
		Manecilla rotativa porcelana Cru Cru porcelain rotary knob Manette rotative porcelaine Cru	+ tornillos patiné + patinated screws + vis patinées	Pack 1 ud.	30	967	88	1
				Pack 5 uds.	30	967	88	7
		Manecilla rotativa porcelana retro blanca Retro white porcelain rotary knob Manette rotative porcelaine rétro blanche	+ tornillos patiné + patinated screws + vis patinées	Pack 1 ud.	30	930	17	1
				Pack 5 uds.	30	930	17	7
		Manecilla rotativa porcelana retro negra Retro black porcelain rotary knob Manette rotative porcelaine rétro noire	+ tornillos negros + black screws + vis noire	Pack 1 ud.	30	930	27	1
				Pack 5 uds.	30	930	27	7

Madera / Wood / Bois • Latón / Brass / Laiton					Serie Series Série	Función Function Fonction	Acabado Finish Finition	Código Code Code
		Manecilla rotativa haya color miel Honey-colour beech rotary knob Manette rotative hêtre couleur miel	+ tornillos patiné + patinated screws + vis patinées	Pack 1 ud.	30	967	19	1
				Pack 5 uds.	30	967	19	7
		Manecilla rotativa haya envejecida Aged beech rotary knob Manette rotative hêtre vieilli	+ tornillos patiné + patinated screws + vis patinées	Pack 1 ud.	30	967	21	1
				Pack 5 uds.	30	967	21	7
		Manecilla rotativa haya natural Natural beech rotary knob Manette rotative hêtre naturel	+ tornillos patiné + patinated screws + vis patinées	Pack 1 ud.	30	967	81	1
				Pack 5 uds.	30	967	81	7
		Manecilla rotativa haya sin barniz Beech without varnish rotary knob Manette rotative hêtre sans vernis	+ tornillos patiné + patinated screws + vis patinées	Pack 1 ud.	30	967	00	1
				Pack 5 uds.	30	967	00	7
		Manecilla rotativa cobre brillo Polished copper-colour rotary knob Manette rotative cuivre brillant	+ tornillos cobre + copper screws + vis cuivre	Pack 1 ud.	30	967	31	1
				Pack 5 uds.	30	967	31	7
		Manecilla rotativa níquel negro Black nickel rotary knob Manette rotative nickel noir	+ tornillos negros + black screws + vis noire	Pack 1 ud.	30	967	30	1
				Pack 5 uds.	30	967	30	7
		Manecilla rotativa latón envejecido Antique brass colour rotary knob Manette rotative laiton vieilli	+ tornillos patiné + patinated screws + vis patinées	Pack 1 ud.	30	967	83	1
				Pack 5 uds.	30	967	83	7
		Manecilla rotativa cromo Chrome-colour rotary knob Manette rotative chrome	+ tornillos cromo + chrome screws + vis chromées	Pack 1 ud.	30	967	26	1
				Pack 5 uds.	30	967	26	7



Interruptor unipolar
Single pole switch
Interrupteur unipolaire

10AX - 250V~

30

306

--

1

Conmutador
Two-way switch
Va-et-vient

10AX - 250V~

30

308

--

1

Cruzamiento
Intermediate switch
Permutateur

10AX - 250V~

30

304

--

1

Interruptor bipolar
Double pole switch
Interrupteur bipolaire

10AX - 250V~

30

314

--

1

**Mecanismo para persianas
(para motores de 1,66A)**
Electric blinds mechanism
(for 1.66A motors)
Mécanisme pour volets roulants
(pour moteurs 1,66A)

10A - 250V~

30

342

--

1

Acabados
Finishes
Finitions

17



27



61



63



15



85



86



87



88



SERIE 30

Pulsadores / Pushbuttons / Poussoirs

Serie
Series
Série

Función
Function
Fonction

Ver acabados
See finishes
Voir finitions

Código
Code
Code

	<p>Pulsador rotativo Rotary pushbutton switch Poussoir rotatif</p>	<p>Posición de reposo Rest position Position de repos</p>		30	328	--	1
	10AX - 250V~	SALIDA / OUTPUT / SORTIE					
	<p>Doble pulsador rotativo Double rotary pushbutton switch Double poussoir rotatif</p>	<p>Posición de reposo Rest position Position de repos</p>		30	344	--	1
	10AX - 250V~	SALIDA / OUTPUT / SORTIE					
	<p>Pulsador de botón Pushbutton Bouton poussoir</p>	10AX - 250V~ 24V DC		30	310	--	2
				Acabados no disponibles: Finishes not available: Finitions non disponibles: 85 - 86 - 87 - 88			
	<p>Pulsador de botón Pushbutton Bouton poussoir</p>	10AX - 250V~ 24V DC		30	312	--	2
	<p>Doble pulsador de botón Double pushbutton Double bouton poussoir</p>	10AX - 250V~ 24V DC		30	343	--	2

Acabados
Finishes
Finitions

17



27



61



63



15



85



86







87



88



	<p>Base de enchufe bipolar sin tomatierra Two-pole socket-outlet without earth contact Prise de courant sans terre</p>	<p>16A - 250V~</p>	<p>30</p>	<p>205</p>	<p>--</p>	<p>2</p>
<p>◀ Carcasa de porcelana / Porcelain case / Carcasse en porcelaine</p>			<p>Acabados no disponibles: Finishes not available: Finitions non disponibles: 85 - 86 - 87 - 88</p>			
	<p>Base de enchufe bipolar con tomatierra lateral Two-pole socket-outlet with side earth contact Prise de courant avec contact latéral de terre</p>	<p>16A - 250V~</p>	<p>30</p>	<p>202</p>	<p>--</p>	<p>2</p>
<p>◀ Carcasa de porcelana / Porcelain case / Carcasse en porcelaine</p>						
	<p>Base de enchufe bipolar francesa con espiga de contacto de tierra French two-pole socket-outlet with earth pin Prise de courant système français avec terre</p>	<p>16A - 250V~</p>	<p>30</p>	<p>211</p>	<p>--</p>	<p>2</p>
<p>◀ Carcasa de porcelana / Porcelain case / Carcasse en porcelaine</p>						
	<p>Base de enchufe bipolar con tomatierra lateral Two-pole socket-outlet with side earth contact Prise de courant avec contact latéral de terre</p>	<p>16A - 250V~</p>	<p>30</p>	<p>204</p>	<p>--</p>	<p>2</p>
<p>◀ Carátula de plástico / Plastic cover / Couvercle en plastique</p>						
	<p>Base de enchufe bipolar francesa con espiga de contacto de tierra French two-pole socket-outlet with earth pin Prise de courant système français avec terre</p>	<p>16A - 250V~</p>	<p>30</p>	<p>208</p>	<p>--</p>	<p>2</p>
<p>◀ Carátula de plástico / Plastic cover / Couvercle en plastique</p>						



SERIE 30

Reguladores de luz / Dimmers / Variateurs

Serie
Series
Série

Función
Function
Fonction

Ver acabados
See finishes
Voir finitions

Código
Code
Code

Mecanismo + regulador / Mechanism + dimmer / Mécanisme + variateur



Regulador rotativo pulsación
Rotary pushbutton dimmer
Régulateur rotatif pulsation

Incandescencia - halógenas 230V~ 40-500W
Incandescent - halogen bulbs 230V~ 40-500W
Incandescence - halogènes 230V~ 40-500W

Transformador mecánico 40-500W
Mechanical transformer 40-500W
Transformateur mécanique 40-500W

30 333 -- 1

Incandescencia - halógenas 230V~ 60-900W
Incandescent - halogen bulbs 230V~ 60-900W
Incandescence - halogènes 230V~ 60-900W

Transformador mecánico 60-900W
Mechanical transformer 60-900W
Transformateur mécanique 60-900W

30 334 -- 1

LED 1-200W

30 3K8 -- 1

LED 1-100W

Incandescencia - halógenas 230V~ 1-400W
Incandescent - halogen bulbs 230V~ 1-400W
Incandescence-halogènes 230V~ 1-400W

Transformador electrónico-electromecánico 1-300W
Electronic-electromechanical transformer 1-300W
Transformateur électronique-électromécanique 1-300W

30 3K9 -- 1

Lámparas fluorescentes compactas (CFL) 1-100W
Compact fluorescent lamps (CFL) 1-100W
Lampes fluorescentes compactes (CFL) 1-100W

0-10V / 1-10V máx. 50mA

30 3L0 -- 1



Los reguladores de pulsación disponen de un dispositivo electrónico que debe ser instalado en una caja anexa al pulsador.

Pushbutton dimmers are fitted with an electronic device that must be installed in a box attached to the pushbutton.

Les variateurs à pousser sont dotés d'un dispositif électronique qui doit être installé dans un boîtier annexe.

Acabados
Finishes
Finitions

17



27



61



63



15



85



86



87



8E



Mecanismo + regulador / Mechanism + dimmer / Mécanisme + variateur



Regulador pulsación
Pushbutton dimmer
Régulateur pulsation

Incandescencia - halógenas 230V~ 40-500W
Incandescent - halogen bulbs 230V~ 40-500W
Incandescence - halogènes 230V~ 40-500W

Transformador mecánico 40-500W
Mechanical transformer 40-500W
Transformateur mécanique 40-500W

30 358 -- 2

Incandescencia - halógenas 230V~ 60-900W
Incandescent - halogen bulbs 230V~ 60-900W
Incandescence - halogènes 230V~ 60-900W

Transformador mecánico 60-900W
Mechanical transformer 60-900W
Transformateur mécanique 60-900W

30 359 -- 2

LED 1-200W

30 3L4 -- 2

LED 1-100W

Incandescencia - halógenas 230V~ 1-400W
Incandescent - halogen bulbs 230V~ 1-400W
Incandescence-halogènes 230V~ 1-400W

Transformador electrónico-electromecánico 1-300W
Electronic-electromechanical transformer 1-300W
Transformateur électronique-électromécanique 1-300W

30 3L5 -- 2

Lámparas fluorescentes compactas (CFL) 1-100W
Compact fluorescent lamps (CFL) 1-100W
Lampes fluorescentes compactes (CFL) 1-100W

0-10V / 1-10V máx. 50mA

30 3L6 -- 2



Los reguladores de pulsación disponen de un dispositivo electrónico que debe ser instalado en una caja anexa al pulsador.

Pushbutton dimmers are fitted with an electronic device that must be installed in a box attached to the pushbutton.

Les variateurs à poussoir sont dotés d'un dispositif électronique qui doit être installé dans un boîtier annexe.

Acabados
Finishes
Finitions

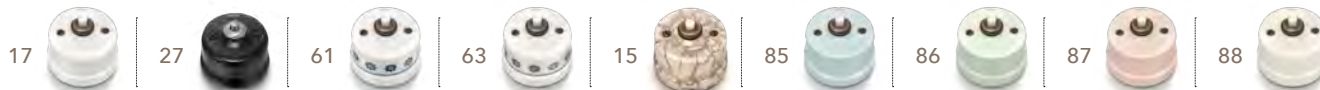

Serie
Series
SérieFunción
Function
FonctionVer acabados
See finishes
Voir finitionsCódigo
Code
Code**Mecanismo + regulador / Mechanism + dimmer / Mécanisme + variateur**

Regulador pulsación
Pushbutton dimmer
Régulateur pulsation

Incandescencia - halógenas 230V~ 40-500W
Incandescent - halogen bulbs 230V~ 40-500W
Incandescence - halogènes 230V~ 40-500W

Transformador mecánico 40-500W
Mechanical transformer 40-500W
Transformateur mécanique 40-500W

30 3L7 -- 2

Incandescencia - halógenas 230V~ 60-900W
Incandescent - halogen bulbs 230V~ 60-900W
Incandescence - halogènes 230V~ 60-900W

Transformador mecánico 60-900W
Mechanical transformer 60-900W
Transformateur mécanique 60-900W

30 3L8 -- 2

LED 1-200W

30 3L9 -- 2

LED 1-100W

Incandescencia - halógenas 230V~ 1-400W
Incandescent - halogen bulbs 230V~ 1-400W
Incandescence-halogènes 230V~ 1-400W

Transformador electrónico-electromecánico 1-300W
Electronic-electromechanical transformer 1-300W
Transformateur électronique-électromécanique 1-300W

30 3M0 -- 2

Lámparas fluorescentes compactas (CFL) 1-100W
Compact fluorescent lamps (CFL) 1-100W
Lampes fluorescentes compactes (CFL) 1-100W

0-10V / 1-10V máx. 50mA

30 3M1 -- 2



Los reguladores de pulsación disponen de un dispositivo electrónico que debe ser instalado en una caja anexa al pulsador.

Pushbutton dimmers are fitted with an electronic device that must be installed in a box attached to the pushbutton.

Les variateurs à poussoir sont dotés d'un dispositif électronique qui doit être installé dans un boîtier annexe.

Acabados
Finishes
Finitions

17



27



61



63



15





Toma señal RTV-SAT ecualizada
R/TV and SAT equalized signal socket
Prise signal RTV-SAT égalisée

Toma única
Single socket
Prise unique

30	712	--	2
----	-----	----	---

Toma intermedia
Intermediate socket
Prise intermédiaire
A

30	713	--	2
----	-----	----	---

Toma intermedia
Intermediate socket
Prise intermédiaire
B

30	714	--	2
----	-----	----	---

Toma final
Final socket
Prise finale

30	709	--	2
----	-----	----	---



Ver información técnica en: See technical information on: Voir informations techniques: **Pg. 190**

Acabados
Finishes
Finitions

17



27



61



63



15



85



86



87



88



SERIE 30

Tomas de voz-datos / Voice-data sockets / Prises téléphone-informatiques

Serie
Series
Série

Función
Function
Fonction

Ver acabados
See finishes
Voir finitions

Código
Code
Code



Doble toma
Double socket
Double prise

Telefonía 6 vías
Telephone 6 ways
Téléphone 6 voies

30	706	--	2
----	-----	----	---

RJ45 CAT6

30	707	--	2
----	-----	----	---

6 vías + RJ45 CAT6

30	708	--	2
----	-----	----	---



Doble toma
Double socket
Double prise

RJ45 CAT6A
apantallado
shielded
blindé

30	761	--	2
----	-----	----	---

Acabados
Finishes
Finitions

17



27



61



63



15



85



86



87



88





Tapa ciega
Blind cover
Couvercle aveugle

30

656

--

2



Salida de cables
Cable outlet cover
Sortie de câbles

Ø 8,5mm

30

927

--

2



SERIE 30

Peanas / Bases / Socles

Serie	Func.	Acab.	Cod.	Serie	Func.	Acab.	Cod.	Serie	Func.	Acab.	Cod.	Serie	Func.	Acab.	Cod.
Series	Funct.	Finish	Code	Series	Funct.	Finish	Code	Series	Funct.	Finish	Code	Series	Funct.	Finish	Code
Serie	Fonct.	Finit.	Code	Serie	Fonct.	Finit.	Code	Serie	Fonct.	Finit.	Code	Serie	Fonct.	Finit.	Code

Madera / Wood / Bois



Haya envejecida
Aged beech
Hêtre vieilli



Haya color miel
Honey-colour beech
Hêtre couleur miel



Haya natural
Natural beech
Hêtre naturel

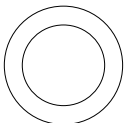
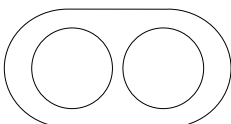
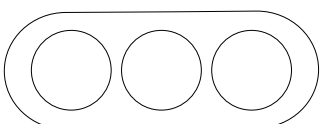

Haya sin barnizar
Unvarnished beech
Hêtre sans vernis

	1 elemento 1 element 1 élément	Ø 95x22mm	30	801	21	2	30	801	19	2	30	801	81	2	30	801	00	2
	2 elementos 2 elements 2 éléments	181x95x22mm	30	802	21	2	30	802	19	2	30	802	81	2	30	802	00	2
	3 elementos 3 elements 3 éléments	252x95x22mm	30	803	21	2	30	803	19	2	30	803	81	2	30	803	00	2



Bastidor con garras para caja universal sin tornillos
Claw support for universal box, without screws
Support à griffes pour boîtier universel sans vis.

20 901 97 2

Solo para peana: Only for base: Uniquement pour socle: **3080X...**



Ver información técnica en: See technical information on: Voir informations techniques: **Pg. 177**

Todas las peanas se venden con adaptador incluido para instalación de superficie o caja empotrada / All bases are sold with attached adaptors for mounting on surface or in embedded box /
Tous les socles sont vendus avec adaptateur inclus pour une installation en surface ou boîtier encastré.

Serie	Func.	Acab.	Cod.	Serie	Func.	Acab.	Cod.	Serie	Func.	Acab.	Cod.	Serie	Func.	Acab.	Cod.
Series	Funct.	Finish	Code	Series	Funct.	Finish	Code	Series	Funct.	Finish	Code	Series	Funct.	Finish	Code
Serie	Fonct.	Finit.	Code	Serie	Fonct.	Finit.	Code	Serie	Fonct.	Finit.	Code	Serie	Fonct.	Finit.	Code

Madera / Wood / Bois

para tubo / for pipe / pour tube

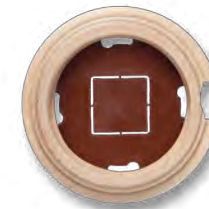

Haya envejecida
Aged beech
Hêtre vieilli

Haya color miel
Honey-colour beech
Hêtre couleur miel

Haya natural
Natural beech
Hêtre naturel

Haya sin barnizar
Unvarnished beech
Hêtre sans vernis

1 elemento 1 element 1 élément		1 agujero 1 hole 1 trou Ø 95x22mm	30 821 21 2	30 821 19 2	30 821 81 2	30 821 00 2
2 elementos 2 elements 2 éléments		1 agujero de instalación vertical 1 vertical installation hole 1 trou installation verticale 181x95x22mm	30 822 21 2	30 822 19 2	30 822 81 2	30 822 00 2
		1 agujero de instalación horizontal 1 horizontal installation hole 1 trou installation horizontale 181x95x22mm	30 832 21 2	30 832 19 2	30 832 81 2	30 832 00 2
3 elementos 3 elements 3 éléments		1 agujero de instalación vertical 1 vertical installation hole 1 trou installation verticale 252x95x22mm	30 823 21 2	30 823 19 2	30 823 81 2	30 823 00 2
		1 agujero de instalación horizontal 1 horizontal installation hole 1 trou installation horizontale 252x95x22mm	30 833 21 2	30 833 19 2	30 833 81 2	30 833 00 2

Serie	Func.	Acab.	Cod.	Serie	Func.	Acab.	Cod.	Serie	Func.	Acab.	Cod.	Serie	Func.	Acab.	Cod.
Series	Funct.	Finish	Code	Series	Funct.	Finish	Code	Series	Funct.	Finish	Code	Series	Funct.	Finish	Code
Serie	Fonct.	Finit.	Code	Serie	Fonct.	Finit.	Code	Serie	Fonct.	Finit.	Code	Serie	Fonct.	Finit.	Code



Haya envejecida
Aged beech
Hêtre vieilli



Haya color miel
Honey-colour beech
Hêtre couleur miel



Haya natural
Natural beech
Hêtre naturel



Haya sin barnizar
Unvarnished beech
Hêtre sans vernis

1 elemento 1 element 1 élément		2 agujeros 2 holes 2 trous Ø 95x22mm	30	841	21	2	30	841	19	2	30	841	81	2	30	841	00	2
2 elementos 2 elements 2 éléments		2 agujeros de instalación vertical 2 vertical installation holes 2 trous installation verticale 181x95x22mm	30	842	21	2	30	842	19	2	30	842	81	2	30	842	00	2
		2 agujeros de instalación horizontal 2 horizontal installation holes 2 trous installation horizontale 181x95x22mm	30	852	21	2	30	852	19	2	30	852	81	2	30	852	00	2
3 elementos 3 elements 3 éléments		2 agujeros de instalación vertical 2 vertical installation holes 2 trous installation verticale 252x95x22mm	30	843	21	2	30	843	19	2	30	843	81	2	30	843	00	2
		2 agujeros de instalación horizontal 2 horizontal installation holes 2 trous installation horizontale 252x95x22mm	30	853	21	2	30	853	19	2	30	853	81	2	30	853	00	2



Ver información técnica en: See technical information on: Voir informations techniques: Pg. 177

GARBY

Collection



SERIE 30

Marcos / Frames / Plaques

Serie	Func.	Acab.	Cod.	Serie	Func.	Acab.	Cod.	Serie	Func.	Acab.	Cod.	Serie	Func.	Acab.	Cod.
Series	Funct.	Finish	Code	Series	Funct.	Finish	Code	Series	Funct.	Finish	Code	Series	Funct.	Finish	Code
Serie	Fonct.	Finit.	Code	Serie	Fonct.	Finit.	Code	Serie	Fonct.	Finit.	Code	Serie	Fonct.	Finit.	Code

Madera / Wood / Bois



LOS MARCOS NECESITAN ADAPTADOR para montar en superficie

FRAMES REQUIRE ADAPTER for surface mounting

LES PLAQUES REQUIÈRENT UN ADAPTATEUR pour un montage en saillie

Pg. 53



Haya envejecida
Aged beech
Hêtre vieilli



Haya color miel
Honey-colour beech
Hêtre couleur miel



Haya natural
Natural beech
Hêtre naturel

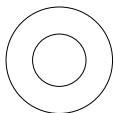
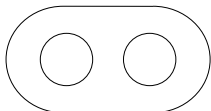
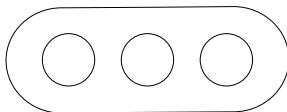
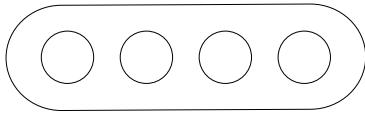

Haya sin barniz
Beech without varnish
Hêtre sans vernis

	1 elemento 1 element 1 élément	Ø 100x12mm	31 801 21 2	31 801 19 2	31 801 81 2	31 801 00 2
	2 elementos 2 elements 2 éléments	175x100x12mm	31 802 21 2	31 802 19 2	31 802 81 2	31 802 00 2
	3 elementos 3 elements 3 éléments	246x100x12mm	31 803 21 2	31 803 19 2	31 803 81 2	31 803 00 2
	4 elementos 4 elements 4 éléments	318x100x12mm	31 804 21 2	31 804 19 2	31 804 81 2	31 804 00 2

Serie	Func.	Acab.	Cod.	Serie	Func.	Acab.	Cod.	Serie	Func.	Acab.	Cod.	Serie	Func.	Acab.	Cod.
Series	Funct.	Finish	Code	Series	Funct.	Finish	Code	Series	Funct.	Finish	Code	Series	Funct.	Finish	Code
Serie	Fonct.	Finit.	Code	Serie	Fonct.	Finit.	Code	Serie	Fonct.	Finit.	Code	Serie	Fonct.	Finit.	Code

Porcelana / Porcelain / Porcelaine



LOS MARCOS NECESITAN ADAPTADOR para montar en superficie

FRAMES REQUIRE ADAPTER for surface mounting

LES PLAQUES REQUIÈRENT UN ADAPTATEUR pour un montage en saillie

Pg. 53



Porcelana blanca
White porcelain
Porcelaine blanche



Porcelana negra
Black porcelain
Porcelaine noire



Porcelana decor
Decor porcelain
Porcelaine décor

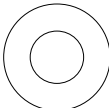
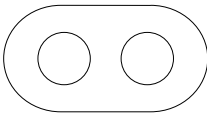
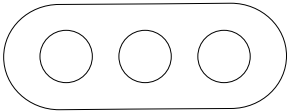

Porcelana craquelé
Craquelé porcelain
Porcelaine craquelé

	1 elemento 1 element 1 élément	Ø 100x12mm	31 801 17 2	31 801 27 2	31 801 61 2	31 801 09 2
	2 elementos 2 elements 2 éléments	175x100x12mm	31 802 17 2	31 802 27 2	31 802 61 2	31 802 09 2
	3 elementos 3 elements 3 éléments	246x100x12mm	31 803 17 2	31 803 27 2	31 803 61 2	31 803 09 2

Serie	Func.	Acab.	Cod.	Serie	Func.	Acab.	Cod.	Serie	Func.	Acab.	Cod.	Serie	Func.	Acab.	Cod.
Series	Funct.	Finish	Code	Series	Funct.	Finish	Code	Series	Funct.	Finish	Code	Series	Funct.	Finish	Code
Serie	Fonct.	Finit.	Code	Serie	Fonct.	Finit.	Code	Serie	Fonct.	Finit.	Code	Serie	Fonct.	Finit.	Code



G A R B Y 2 0 Y E A R S



Coton





Vert ille



Camille

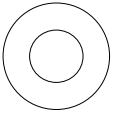
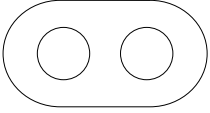
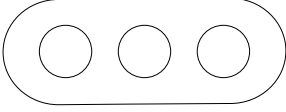

Cru

	1 elemento 1 element 1 élément	Ø 100x12mm	31	801	85	2	31	801	86	2	31	801	87	2	31	801	88	2
	2 elementos 2 elements 2 éléments	175x100x12mm	31	802	85	2	31	802	86	2	31	802	87	2	31	802	88	2
	3 elementos 3 elements 3 éléments	246x100x12mm	31	803	85	2	31	803	86	2	31	803	87	2	31	803	88	2
	Adaptador para marcos en superficie sin chasis. Adapter for surface mounted frames, without socket plate. Adaptateur pour plaques en saillie sans support		Montaje directo sobre superficie Mount directly on the surface Montage direct en surface										30	950	98	2		
	Adaptador para marcos en superficie con chasis. Adapter for surface mounted frames, with socket plate. Adaptateur pour plaques en saillie avec support		Montaje en caja de empotrar Mounted on fitting box Montage boîte d'encastrement										30	951	98	2		



Ver información técnica en: See technical information on: Voir informations techniques: Pg. 177



Cable trenzado ignífugo.
Conductor de PVC blindado con fibra de vidrio
750V.
Rollos 50 m.

2x1,5mm²

30 971 03 2

Fireproof braided wire.
Fibreglass screened 750V PVC conductor.
Rolls 50 m.

3x1,5mm²

30 974 03 2

Câble tressé ignifuge.
Conducteur de PVC blindé avec fibre de verre 750 V.
Rouleau 50 m.

3x2,5mm²

30 975 03 2

30 975 05 2

Cable trenzado. Conductor de PVC con
recubrimiento de algodón 750V.
Rollos 50 m.

2x1,5mm²

30 976 05 2

Braided wire. PVC conductor with cotton coating
750 V.
Rolls 50 m.

3x1,5mm²

30 979 05 2

Câble tressé. Conducteur de PVC recouvert de coton
750 V.
Rouleau 50 m.

Según Reglamento Electrotécnico para Baja Tensión (Real Decreto 842/ 2002) con entrada en vigor el 18 de Septiembre de 2003, el cable trenzado PVC de 750V únicamente es apto para reformas o modificaciones de instalaciones existentes que no afecten a más del 50% de la potencia instalada.

Consult local regulations for the use of this cable.

Consulter les réglementations locales pour l'utilisation de ce câble.

Aislador de porcelana para cable trenzado
Porcelain insulator for braided wire
Isolateur porcelaine pour câble tressé

Ø 19mm
↓
20mm

Pack 25 uds.

30 913 17 0

30 913 47 0

Distancia recomendable entre cada aislador: 40cm
Recommended distance between each insulator: 40cm
Distance conseillée entre chaque isolateur: 40 cm

Pack 5 uds.

30 913 17 2

30 913 47 2



Acabado
Finish
Finition



05 Blanco
White
Blanc







03 Marrón
Brown
Marron







17 Porcelana blanca
White porcelain
Porcelaine blanche







47 Porcelana marrón
Brown porcelain
Porcelaine marron

				Serie Series Série	Función Function Fonction	Acabado Finish Finition	Código Code Code	
	Tapón pasamuros. ↓ 19mm para tubo de 16mm Wall grommet. ↓ 19 mm for 16 mm pipe Bouchon traversant. ↓ 19 mm pour tube de 16 mm	Ø 26mm	Pack 2 uds.	30	938	03	2	
				30	938	05	2	
	Florón para lámpara Ceiling rose Fleuron pour lampe	Ø 100x34mm		30	940	17	2	
	Caja de empalmes Junction box Boîtier de derivation	Ø 78mm ↓ 46mm		30	399	17	2	
				30	399	27	2	
			Ø 118mm ↓ 53mm	30	401	17	2	
				30	401	27	2	
	Caja de empalmes metálica Metallic junction box Boîtier de derivation métallique	Ø 72x46mm		30	399	22	2	
			Ø 108x53mm	30	401	22	2	
			175x125x50mm	30	402	22	2	
	Tubo metálico para instalación en superficie Metallic pipe for surface mounting Tube métallique pour installation en saillie	Ø 16mm	Pack 4 uds. x 3m. Total 12m	30	016	22	2	
				Ø 20mm	30	020	22	2
				Ø 25mm	30	025	22	2

Acabado
Finish
Finition17 Porcelana blanca
White porcelain
Porcelaine blanche27 Porcelana negra
Black porcelain
Porcelaine noire22 Metal envejecido
Aged metal
Métal vieilli47 Porcelana marrón
Brown porcelain
Porcelaine marron05 Blanco
White
Blanc03 Marrón
Brown
Marron

	Grapa metálica para fijación de tubo Wall mount pipe bracket Agrafe métallique pour fixation de tube	Ø 16mm	Pack 25 uds.	30	716	03	2
		Ø 20mm		30	720	03	2
		Ø 25mm		30	725	03	2
	Abrazadera para fijación de tubo Wall mount conduit clamp Collier pour fixation de tube	Ø 16mm	Pack 25 uds.	30	816	03	2
		Ø 20mm		30	820	03	2
		Ø 25mm		30	825	03	2
	Manguito para unión de tubos Conduit coupler Bague pour assemblage de tubes	Ø 16mm	Pack 10 uds.	30	516	22	2
		Ø 20mm		30	520	22	2
		Ø 25mm	Pack 5 uds.	30	525	22	2
	Codo con registro para tubo Inspection elbow Coude pour tube	Ø 16mm		30	116	22	2
		Ø 20mm		30	120	22	2
		Ø 25mm		30	125	22	2
	Curva 90° para tubo* 90° pipe bend Courbe 90° pour tube	Ø 16mm		30	416	22	2
		Ø 20mm		30	420	22	2
		Ø 25mm		30	425	22	2

(*) Para una instalación en superficie completa, los manguitos son necesarios para unir la curva al tubo / For complete surface mounting, conduit couplers are necessary to join the pipe bend. / Pour une installation en saillie complète, les bagues sont nécessaires pour assembler la courbe au tube.

			Serie Series Série	Función Function Fonction	Acabado Finish Finition	Código Code Code
	Derivador T con registro para tubo Pipe inspection tee-joint Dérivateur T pour tube	Ø 16mm	30	616	22	2
		Ø 20mm	30	620	22	2
		Ø 25mm	30	625	22	2
	Adaptador para tubo de Ø20mm en peana Adaptor for Ø20mm conduit in base Adaptateur pour tube de Ø20mm sur socle		30	007	03	2
	Suplemento de altura Dimbler para peana tubo Garby Dimbler height supplement for Garby pipe base Rehausseur Dimbler pour socle tube Garby		60	952	03	2
	Plantilla aislante para mecanismos de superficie Insulating template for surface mounted mechanisms Base isolante pour mécanismes de surface		30	952	02	2
	Spray reparador de pintura 400ml Painted finish repair spray: 400ml Spray réparateur de peinture 400 ml		30	001	22	2

Acabado
Finish
Finition

 22 Metal envejecido
Aged metal
Métal vieilli

 05 Blanco
White
Blanc

 03 Marrón
Brown
Marron

DIMBLER

Collection

Fontini
BY *Fontini*



DIMBLER

Collection



Mecanismos compatibles con los marcos y accesorios de la Colección Garby y con los marcos de la de la Colección Venezia.

Combinable mechanisms with frames and accessories of Garby Collection and Venezia Collection frames.

Mécanismes compatibles avec les plaques et accessoires des Collection Garby et avec les plaques de la Collection Venezia.

-
- Instalación de superficie
 - Mecanismos de 10AX 250V~
 - Contactos de plata de alto poder de ruptura
 - Construida con porcelana y latón
 - Combinable con peanas Garby y marcos Venezia

-
- Surface installation
 - 10AX 250V~ mechanisms
 - Silver contacts with high breaking power
 - Manufactured with porcelain and brass
 - Usable with Garby and Venezia frames

-
- Installation en saillie
 - Mécanismes de 10AX 250V~
 - Contacts en argent avec haut pouvoir de rupture
 - Fabriqués en porcelaine et laiton
 - Compatible avec les plaques Garby et Venezia
-

DIMBLER

Collection

SERIE 60

Acabados / Finishes / Finitions

Porcelana con paso de cable / Porcelain with gap for wire / Porcelaine avec passe-câble



41



42



43



44



45

Porcelana sin paso de cable / Porcelain without gap for wire / Porcelaine sans passe-câble



61



62



63



64



65

Manecilla níquel negro
Black nickel knob
Manette nickel noire

Manecilla cobre brillo
Polished copper knob
Manette cuivre brillante

Manecilla dorado brillo
Polished golden knob
Manette dorée brillante

Manecilla cromo brillo
Polished chrome knob
Manette chromé brillante

Manecilla latón envejecido
Aged brass knob
Manette laiton vieillie

Porcelana con paso de cable / Porcelain with gap for wire / Porcelaine avec passe-câble



21



22



23



24



25

Porcelana sin paso de cable / Porcelain without gap for wire / Porcelaine sans passe-câble



31

Manecilla níquel negro
Black nickel knob
Manette nickel noire



32

Manecilla cobre brillo
Polished copper knob
Manette cuivre brillante



33

Manecilla dorado brillo
Polished golden knob
Manette dorée brillante



34

Manecilla cromo brillo
Polished chrome knob
Manette chromé brillante



35

Manecilla latón envejecido
Aged brass knob
Manette laiton vieillie



Interruptor-conmutador
Two-way switch
Va-et-vient

10AX - 250V~

60

308

--

2

Cruzamiento
Intermediate switch
Permutateur

10AX - 250V~

60

304

--

2

Interruptor bipolar
Double pole switch
Interrupteur bipolaire

10AX - 250V~

60

314

--

2



SERIE 60

Pulsadores / Pushbuttons / Poussoirs

Serie
Series
Série

Función
Function
Fonction

Ver acabados
See finishes
Voir finitions

Código
Code
Code



Pulsador toggle
Toggle pushbutton
Bouton poussoir toggle

10AX - 250V~
24V DC

60

312

--

2

Sin paso de cable
Without gap for wire
Sans passe-câble

61



62



63



64



65



31



32



33



34



35



65

DIMBLER

Collection

SERIE 60
Acabados / Finishes / Finitions

Metal con paso de cable / Metal with gap for wire / Métal avec passe-câble



52



70



81



72



51

Metal sin paso de cable / Metal without gap for wire / Métal sans passe-câble



59



71



68



82



56

Cúpula dorado satinado
Satin gold dome
Carcasse dorée satinée

Manecilla dorado brillo
Polished golden knob
Manette dorée brillante

Cúpula patiné satinado
Antique bronze dome
Carcasse bronze ancien

Manecilla latón envejecido
Aged brass knob
Manette laiton vieillie

Cúpula cromo brillo
Polished chrome dome
Carcasse chromé brillante

Manecilla cromo brillo
Polished chrome knob
Manette chromé brillante

Cúpula cobre brillo
Polished copper dome
Carcasse cuivre brillante

Manecilla cobre brillo
Polished copper knob
Manette cuivre brillante

Cúpula níquel satinado
Satin nickel dome
Carcasse nickel satiné

Manecilla cromo brillo
Polished chrome knob
Manette chromé brillante

Metal con paso de cable / Metal with gap for wire / Métal avec passe-câble



74



75



77



78



79

Metal sin paso de cable / Metal without gap for wire / Métal sans passe-câble



84



85



87



88



89

Cúpula dorado satinado
Satin gold dome
Carcasse dorée satinée

Manecilla dorado brillo
Polished golden knob
Manette dorée brillante

Cúpula patiné satinado
Antique bronze dome
Carcasse bronze ancien

Manecilla latón envejecido
Aged brass knob
Manette laiton vieillie

Cúpula cromo brillo
Polished chrome dome
Carcasse chromé brillante

Manecilla cromo brillo
Polished chrome knob
Manette chromé brillante

Cúpula cobre brillo
Polished copper dome
Carcasse cuivre brillante

Manecilla cobre brillo
Polished copper knob
Manette cuivre brillante

Cúpula níquel negro
Black nickel dome
Carcasse nickel noir

Manecilla níquel negro
Black nickel knob
Manette nickel noir



Interruptor - Conmutador
Switch - Two-way switch
Interrupteur - Va-et-vient

10AX - 250V~

60

308

--

2

Cruzamiento
Intermediate switch
Permutateur

10AX - 250V~

60

304

--

2

Interruptor bipolar
Double pole switch
Interrupteur bipolaire

10AX - 250V~

60

314

--

2



SERIE 60

Pulsadores / Pushbuttons / Poussoirs

Serie
Series
Série

Función
Function
Fonction

Ver acabados
See finishes
Voir finitions

Código
Code
Code



Pulsador de manecilla
Toggle pushbutton
Bouton poussoir

10AX - 250V~
24V DC

60

312

--

2



Pulsador de botón
Pushbutton
Bouton poussoir

10AX - 250V~
24V DC

60

310

--

2

Sin paso de cable
Without gap for wire
Sans passe-câble

59



71



68



82



56



84



85



87



88



89





DO Collection

Manecillas / Knobs / Manettes (pg. 76)

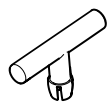

Mecanismos / Mechanisms / Mécanismes (pg. 78)

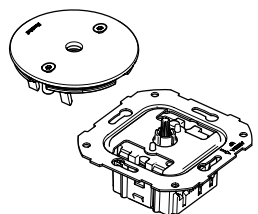

Marcos / Frames / Plaques (pg. 90)

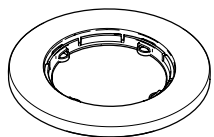

-
- Instalación empotrada
 - Mecanismos de 10AX 250V~
 - Bases de enchufe de 16A 250V~
 - Contactos de plata de alto poder de ruptura
 - Construida con porcelana y termoplásticos técnicos
 - Marcos de madera y porcelana
 - Marcos para instalar en posición vertical u horizontal
-

- Fitting installation
 - 10AX 250V~ mechanisms
 - 16A 250V~ sockets
 - Silver contacts with high breaking power
 - Manufactured with porcelain and technical thermoplastic materials
 - Wood and porcelain frames
 - Frames for vertical or horizontal installations, fitted in universal boxes
-

- Installation encastrée
 - Mécanismes de 10AX 250V~
 - Prises de courant 16A 250V~
 - Contacts en argent avec haut pouvoir de rupture
 - Fabriqués en porcelaine et a partir de techniques thermoplastiques
 - Plaques en bois et porcelaine
 - Plaques pour installation horizontale ou verticale en saillie dans boîtiers universel
-
-

DO
Collection



SERIE 34
Acabados / Finishes / Finitions



11

Porcelana blanca
White porcelain
Porcelaine blanche

Botón/tornillos metal cromo
Chrome-colour metal button/screws
Bouton/vis métal chrome



12

Porcelana blanca
White porcelain
Porcelaine blanche

Botón/tornillos metal níquel negro
Black nickel button/screws
Bouton/vis métal nickel noir



13

Porcelana blanca
White porcelain
Porcelaine blanche

Botón/tornillos metal cobre brillo
Polished copper-colour metal button/screws
Bouton/vis métal cuivre brillant



01

Porcelana negra
Black porcelain
Porcelaine noire

Botón/tornillos metal cromo
Chrome-colour metal button/screws
Bouton/vis métal chrome



02

Porcelana negra
Black porcelain
Porcelaine noire

Botón/tornillos metal níquel negro
Black nickel button/screws
Bouton/vis métal nickel noir



03

Porcelana negra
Black porcelain
Porcelaine noire

Botón/tornillos metal cobre brillo
Polished copper-colour metal button/screws
Bouton/vis métal cuivre brillant



Manecilla rotativa metal cromo
Chrome-colour metal rotary knob
Manette rotative métal chrome



Pack 1 ud.

34 967 26 1

Pack 5 uds.

34 967 26 7

Manecilla rotativa metal níquel negro
Black nickel metal rotary knob
Manette rotative métal nickel noire



Pack 1 ud.

34 967 30 1

Pack 5 uds.

34 967 30 7

Manecilla rotativa metal cobre brillo
Polished copper-colour metal rotary knob
Manette rotative métal cuivre brillant



Pack 1 ud.

34 967 31 1

Pack 5 uds.

34 967 31 7





Interruptor unipolar- Conmutador
Single pole switch - Two-way switch
Interrupteur unipolaire- Va-et-vient

10AX - 250V~

34 308 -- 1

Cruzamiento
Intermediate switch
Permutateur

10AX - 250V~

34 304 -- 1

Interruptor bipolar
Double pole switch
Interrupteur bipolaire

10AX - 250V~

34 314 -- 1

Mecanismo para persianas (para motores de 1,66A)
Electric blinds mechanism (for 1.66A motors)
Mécanisme pour volets roulants (pour moteurs 1,66A)

10A - 250V~

34 342 -- 1

Doble conmutador
Double two-way switch
Double va-et-vient

10AX - 250V~

34 302 -- 1



SERIE 34

Pulsadores / Pushbuttons / Poussoirs

Serie
Series
Série

Función
Function
Fonction

Ver acabados
See finishes
Voir finitions

Código
Code
Code



Pulsador rotativo
Rotary pushbutton switch
Poussoir rotatif

10AX - 250V~

Posición de reposo
Rest position
Position de repos

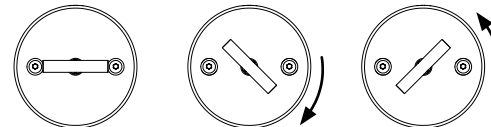

SALIDA / OUTPUT / SORTIE

OFF

ON

ON

34

328

--

1

Doble pulsador rotativo
Double rotary pushbutton switch
Double poussoir rotatif

10AX - 250V~

Posición de reposo
Rest position
Position de repos

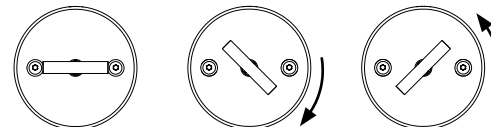

SALIDA / OUTPUT / SORTIE

OFF

ON 1

ON 2

34

344

--

1



Pulsador
Pushbutton
Bouton poussoir

10AX - 250V~

34

310

--

2

Acabados
Finishes
Finitions

11



12



13



01



02



03





Base de enchufe bipolar con tomatierra lateral
Two-pole socket-outlet with side earth contact
Prise de courant avec contact latéral de terre

16A - 250V~

34

212

--

2



Base de enchufe bipolar francesa con espiga de contacto de tierra
French two-pole socket-outlet with earth pin
Prise de courant système français avec terre

16A - 250V~

34

208

--

2





Mecanismo + regulador / Mechanism + dimmer / Mécanisme + variateur



Regulador rotativo pulsación
Rotary pushbutton dimmer
Régulateur rotatif pulsation

Incandescencia - halógenas 230V~ 40-500W
Incandescent - halogen bulbs 230V~ 40-500W
Incandescence - halogènes 230V~ 40-500W

Transformador mecánico 40-500W
Mechanical transformer 40-500W
Transformateur mécanique 40-500W

34 333 -- 1

Incandescencia - halógenas 230V~ 60-900W
Incandescent - halogen bulbs 230V~ 60-900W
Incandescence - halogènes 230V~ 60-900W

Transformador mecánico 60-900W
Mechanical transformer 60-900W
Transformateur mécanique 60-900W

34 334 -- 1

LED 1 - 200W

34 3K8 -- 1

LED 1-100W

Incandescencia - halógenas 230V~ 1-400W
Incandescent - halogen bulbs 230V~ 1-400W
Incandescence-halogènes 230V~ 1-400W

Transformador electrónico-electromecánico 1-300W
Electronic-electromechanical transformer 1-300W
Transformateur électronique-électromécanique 1-300W

34 3K9 -- 1

Lámparas fluorescentes compactas (CFL) 1-100W
Compact fluorescent lamps (CFL) 1-100W
Lampes fluorescentes compactes (CFL) 1-100W

0-10V / 1-10V máx. 50mA

34 3L0 -- 1



Los reguladores de pulsación disponen de un dispositivo electrónico que debe ser instalado en una caja anexa al pulsador.

Pushbutton dimmers are fitted with an electronic device that must be installed in a box attached to the pushbutton.

Les variateurs à poussoir sont dotés d'un dispositif électronique qui doit être installé dans un boîtier annexe.



Serie
Series
Série

Función
Function
Fonction

Ver acabados
See finishes
Voir finitions

Código
Code
Code

Mecanismo + regulador / Mechanism + dimmer / Mécanisme + variateur



Regulador pulsación botón
Pushbutton dimmer
Régulateur pulsation bouton

Incandescencia - halógenas 230V~ 40-500W
Incandescent - halogen bulbs 230V~ 40-500W
Incandescence - halogènes 230V~ 40-500W

Transformador mecánico 40-500W
Mechanical transformer 40-500W
Transformateur mécanique 40-500W

Incandescencia - halógenas 230V~ 60-900W
Incandescent - halogen bulbs 230V~ 60-900W
Incandescence - halogènes 230V~ 60-900W

Transformador mecánico 60-900W
Mechanical transformer 60-900W
Transformateur mécanique 60-900W

LED 1 - 200W

LED 1-100W

Incandescencia - halógenas 230V~ 1-400W
Incandescent - halogen bulbs 230V~ 1-400W
Incandescence-halogènes 230V~ 1-400W

Transformador electrónico-electromecánico 1-300W
Electronic-electromechanical transformer 1-300W
Transformateur électronique-électromécanique 1-300W

Lámparas fluorescentes compactas (CFL) 1-100W
Compact fluorescent lamps (CFL) 1-100W
Lampes fluorescentes compactes (CFL) 1-100W

0-10V / 1-10V máx. 50mA

34 358 -- 2

34 359 -- 2

34 3L4 -- 2

34 3L5 -- 2

34 3L6 -- 2



Los reguladores de pulsación disponen de un dispositivo electrónico que debe ser instalado en una caja anexa al pulsador.

Pushbutton dimmers are fitted with an electronic device that must be installed in a box attached to the pushbutton.

Les variateurs à poussoir sont dotés d'un dispositif électronique qui doit être installé dans un boîtier annexe.

Acabados
Finishes
Finitions

11



12



13



01



02



03





Regulador motores rotativo
Rotary fan dimmer
Variateur pour moteurs rotatif

40-250W

34 331 -- 2

Regulador-conmutador rotativo
Rotary dimmer (two-way switch)
Régulateur rotatif (va-et-vient)

LED 10-120W (Máx. 10 lámparas)
Incandescencia - halógenas 10-300W
Incandescent - halogen bulbs 10-300W
Incandescence - halogènes 10-300W

Transformador electrónico 10-300W
Electronic transformer 10-300W
Transformateur électronique 10-300W

34 3A9 -- 2

Regulador-conmutador rotativo universal
Universal rotary dimmer (two-way switch)
Régulateur rotatif (va-et-vient) universel

LED 230V 4-100W
Incandescencia - halógenas 25-400W
Incandescent - halogen bulbs 25-400W
Incandescence - halogènes 25-400W

Transformador electrónico-electromecánico 25-400W
Electronic-electromechanical transformer 25-400W
Transformateur électronique-électromécanique 25-400W

34 330 -- 2

Regulador-conmutador de botón
Pushbutton dimmer switch
Régulateur-commutateur à bouton

Incandescencia - halógenas 60-400W
Incandescent - halogen bulbs 60-400W
Incandescence - halogènes 60-400W

Transformador electrónico 60-400W
Electronic transformer 60-400W
Transformateur électronique 60-400W

34 332 -- 2

0-10V / 1-10V máx.20mA

34 3E7 -- 2



SERIE 34

Tomas de televisión / Television sockets / Prises télévision

Serie
Series
Série

Función
Function
Fonction

Ver acabados
See finishes
Voir finitions

Código
Code
Code



Toma señal RTV-SAT ecualizada
R/TV and SAT equalized signal socket
Prise signal RTV-SAT égalisée

Toma única
Single socket
Prise unique

34	712	--	2
----	-----	----	---

Toma intermedia
Intermediate socket
Prise intermédiaire
A

34	713	--	2
----	-----	----	---

Toma intermedia
Intermediate socket
Prise intermédiaire
B

34	714	--	2
----	-----	----	---

Toma final
Final socket
Prise finale

34	711	--	2
----	-----	----	---



Ver información técnica en: See technical information on: Voir informations techniques: **Pg. 190**

Acabados
Finishes
Finitions

17



27





Doble toma
Double socket
Double prise

Telefonía 6 vías
Telephone 6 ways
Téléphone 6 voies

34	706	--	2
----	-----	----	---

RJ45 CAT6

34	707	--	2
----	-----	----	---

6 vías + RJ45 CAT6

34	708	--	2
----	-----	----	---



Doble toma
Double socket
Double prise

RJ45 CAT6A
apantallado
shielded
blindé

34	761	--	2
----	-----	----	---



SERIE 34





Tomas multimedia / Multimedia sockets / Prises multimédia

Serie
Series
Série

Función
Function
Fonction

Ver acabados
See finishes
Voir finitions

Código
Code
Code

	Doble toma Double socket Double prise	HDMI	34	726	--	2
	Doble toma* Double socket Double prise	HDMI+USB	34	743	--	2
	Doble toma Double socket Double prise	HDMI+RJ45 CAT6	34	728	--	2
	Doble toma* Double socket Double prise	USB Adaptador hembra-hembra Female-female adapter Adaptateur femelle-femelle	34	729	--	2

Acabados
Finishes
Finitions

17





27



* Las tomas USB no son cargadores USB / USB sockets are not charging sockets / USB prise n'est pas un chargeur USB

EMPOTRADA FITTING ENCASTRÉE

	<p>Doble toma* Double socket Double prise</p>	<p>USB+RJ45 CAT6</p>	<p>34</p>	<p>719</p>	<p>--</p>	<p>2</p>
	<p>Toma audio Audio socket Prise audio</p>	<p>RCA</p>	<p>34</p>	<p>907</p>	<p>--</p>	<p>2</p>
	<p>Cargador doble USB Dual USB charger Chargeur 2 ports USB</p>	<p>5V 2,6A</p>	<p>34</p>	<p>765</p>	<p>--</p>	<p>2</p>



Ver información técnica en: See technical information on: Voir informations techniques: **Pg. 189**



SERIE 34
Otras funciones / Other functions / Autres fonctions

Serie
Series
Série

Función
Function
Fonction

Ver acabados
See finishes
Voir finitions

Código
Code
Code



Tapa ciega
Blind cover
 Couverture aveugle

34 656 -- 2



Salida de cables
Cable outlet cover
 Sortie de câbles

Ø 8mm

34 927 -- 2

Acabados
Finishes
Finitions

11



12



13



01



02



03



EMPOTRADA FITTING ENCASTRÉE

Porcelana / Porcelain / Porcelaine



Porcelana blanca
White porcelain
Porcelaine blanche

Porcelana negra
Black porcelain
Porcelaine noire

	<p>1 elemento 1 element 1 élément</p>	<p>Ø 100x9mm</p>	<p>34 801 17 2</p>	<p>34 801 27 2</p>
	<p>2 elementos 2 elements 2 éléments</p>	<p>171x100x9mm</p>	<p>34 802 17 2</p>	<p>34 802 27 2</p>
	<p>3 elementos 3 elements 3 éléments</p>	<p>243x100x9mm</p>	<p>34 803 17 2</p>	<p>34 803 27 2</p>

Serie	Func.	Acab.	Cod.	Serie	Func.	Acab.	Cod.	Serie	Func.	Acab.	Cod.
Series	Funct.	Finish	Code	Series	Funct.	Finish	Code	Series	Funct.	Finish	Code
Serie	Fonct.	Finit.	Code	Serie	Fonct.	Finit.	Code	Serie	Fonct.	Finit.	Code

Madera / Wood / Bois



Haya oscurecida
Darkened beech
Hêtre obscurci

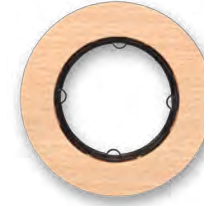

Haya natural
Natural beech
Hêtre naturel

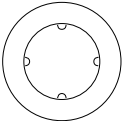
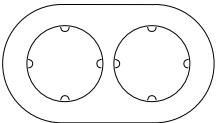
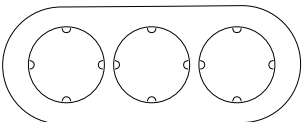

Nogal
Walnut
Noyer

	1 elemento 1 element 1 élément	Ø 100x9mm	34	801	80	2	34	801	81	2	34	801	82	2
	2 elementos 2 elements 2 éléments	171x100x9mm	34	802	80	2	33	802	81	2	33	802	82	2
	3 elementos 3 elements 3 éléments	243x100x9mm	34	803	80	2	34	803	81	2	34	803	82	2



EMPOTRADA FITTING ENCASTRÉE

GARBY Colonial Collection

Manecillas y Tornillos / Knobs and screws / Manettes et vis (pg. 98)

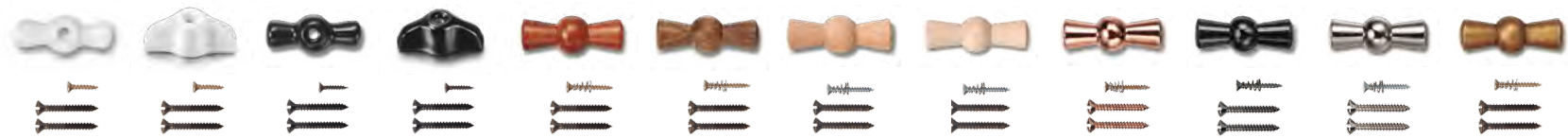
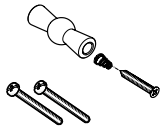

Mecanismos / Mechanisms / Mécanismes (pg. 100)

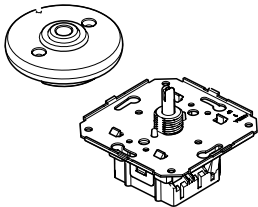

Marcos / Frames / Plaques (pg. 114)

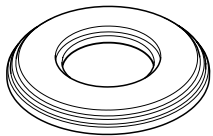

-
- Instalación empotrada
 - Mecanismos de 10AX 250V~
 - Bases de enchufe de 16A 250V~
 - Contactos de plata de alto poder de ruptura
 - Construida con porcelana y termoplásticos técnicos
 - Marcos de madera y porcelana
 - Marcos para instalar en posición vertical u horizontal

-
- Fitting installation
 - 10AX 250V~ mechanisms
 - 16A 250V~ sockets
 - Silver contacts with high breaking power
 - Manufactured with porcelain and technical thermoplastic materials
 - Wood and porcelain frames
 - Frames for vertical or horizontal installations, fitted in universal boxes

-
- Installation encastrée
 - Mécanismes de 10AX 250V~
 - Prises de courant 16A 250V~
 - Contacts en argent avec haut pouvoir de rupture
 - Fabriqués en porcelaine et a partir de techniques thermoplastiques
 - Plaques en bois et porcelaine
 - Plaques pour installation horizontale ou verticale en saillie dans boîtiers universel
-
-

GARBY
Colonial
Collection



SERIE 31
Acabados / Finishes / Finitions















17
Porcelana blanca
White porcelain
Porcelaine blanche



27
Porcelana negra
Black porcelain
Porcelaine noire

Porcelana / Porcelain / Porcelaine • Madera / Wood / Bois

		<p>Manecilla rotativa porcelana blanca White porcelain rotary knob Manette rotative porcelaine blanche</p>	<p>+ tornillos patiné + patinated screws + vis patinées</p>	Pack 1 ud.	30	967	17	1
				Pack 5 uds.	30	967	17	7
		<p>Manecilla rotativa porcelana negra Black porcelain rotary knob Manette rotative porcelaine noire</p>	<p>+ tornillos negros + black screws + vis noire</p>	Pack 1 ud.	30	967	27	1
				Pack 5 uds.	30	967	27	7
		<p>Manecilla rotativa porcelana retro blanca Retro white porcelain rotary knob Manette rotative porcelaine rétro blanche</p>	<p>+ tornillos patiné + patinated screws + vis patinées</p>	Pack 1 ud.	30	930	17	1
				Pack 5 uds.	30	930	17	7
		<p>Manecilla rotativa porcelana retro negra Retro black porcelain rotary knob Manette rotative porcelaine rétro noire</p>	<p>+ tornillos negros + black screws + vis noire</p>	Pack 1 ud.	30	930	27	1
				Pack 5 uds.	30	930	27	7
		<p>Manecilla rotativa haya color miel Honey-colour beech rotary knob Manette rotative hêtre couleur miel</p>	<p>+ tornillos patiné + patinated screws + vis patinées</p>	Pack 1 ud.	30	967	19	1
				Pack 5 uds.	30	967	19	7
		<p>Manecilla rotativa haya envejecida Aged beech rotary knob Manette rotative hêtre vieilli</p>	<p>+ tornillos patiné + patinated screws + vis patinées</p>	Pack 1 ud.	30	967	21	1
				Pack 5 uds.	30	967	21	7







Serie
Series
Série

Función
Function
Fonction

Acabado
Finish
Finition

Código
Code
Code

Madera / Wood / Bois • Latón / Brass / Laiton

	<p>Manecilla rotativa haya natural Natural beech rotary knob Manette rotative hêtre naturel</p>	<p>+ tornillos patiné + patinated screws + vis patinées</p>	Pack 1 ud.	30	967	81	1
			Pack 5 uds.	30	967	81	7
	<p>Manecilla rotativa haya sin barniz Beech without varnish rotary knob Manette rotative hêtre sans vernis</p>	<p>+ tornillos patiné + patinated screws + vis patinées</p>	Pack 1 ud.	30	967	00	1
			Pack 5 uds.	30	967	00	7
	<p>Manecilla rotativa cobre brillo Polished copper-colour rotary knob Manette rotative cuivre brillant</p>	<p>+ tornillos cobre + copper screws + vis cuivre</p>	Pack 1 ud.	30	967	31	1
			Pack 5 uds.	30	967	31	7
	<p>Manecilla rotativa níquel negro Black nickel rotary knob Manette rotative nickel noir</p>	<p>+ tornillos negros + black screws + vis noire</p>	Pack 1 ud.	30	967	30	1
			Pack 5 uds.	30	967	30	7
	<p>Manecilla rotativa latón envejecido Antique brass colour rotary knob Manette rotative laiton vieilli</p>	<p>+ tornillos patiné + patinated screws + vis patinées</p>	Pack 1 ud.	30	967	83	1
			Pack 5 uds.	30	967	83	7
	<p>Manecilla rotativa cromo Chrome-colour rotary knob Manette rotative chrome</p>	<p>+ tornillos cromo + chrome screws + vis chromées</p>	Pack 1 ud.	30	967	26	1
			Pack 5 uds.	30	967	26	7



Interruptor unipolar
Single pole switch
Interrupteur unipolaire

10AX - 250V~

31 306 -- 1

Conmutador
Two-way switch
Va-et-vient

10AX - 250V~

31 308 -- 1

Cruzamiento
Intermediate switch
Permutateur

10AX - 250V~

31 304 -- 1

Interruptor bipolar
Double pole switch
Interrupteur bipolaire

10AX - 250V~

31 314 -- 1

**Mecanismo para persianas
(para motores de 1,66A)**
Electric blinds mechanism
(for 1.66A motors)
Mécanisme pour volets roulants
(pour moteurs 1,66A)

10A - 250V~

31 342 -- 1



Serie
Series
Série

Función
Function
Fonction

Ver acabados
See finishes
Voir finitions

Código
Code
Code



Doble interruptor
Double switch
Double interrupteur

10AX-250V~

31

300

--

1

Doble conmutador
Double two-way switch
Double va-et-vient

10AX-250V~

31

302

--

1



Acabados
Finishes
Finitions

17



27

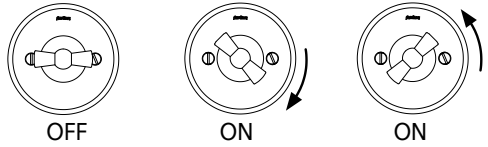
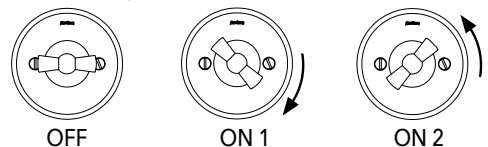

	<p>Pulsador rotativo Rotary pushbutton switch Poussoir rotatif</p>	<p>Posición de reposo Rest position Position de repos</p>		31	328	--	1
	10AX - 250V~	SALIDA / OUTPUT / SORTIE					
	<p>Doble pulsador rotativo Double rotary pushbutton switch Double poussoir rotatif</p>	<p>Posición de reposo Rest position Position de repos</p>		31	344	--	1
	10AX - 250V~	SALIDA / OUTPUT / SORTIE					
	<p>Pulsador de botón Pushbutton Bouton poussoir</p>	10AX - 250V~ 24V DC		31	310	--	2
	<p>Pulsador temporizador * Timer pushbutton Bouton poussoir temporisateur</p>	10AX - 250V~		31	316	--	2
	<p>*30seg a 10min. Incandescencia y halógenas 30 sec. to 10 min. Incandescent and halogen 30 sec. à 10 min. Incandescence et halogène.</p>						
	<p>Doble pulsador de botón Double pushbutton Double bouton poussoir</p>	10AX - 250V~ 24V DC		31	343	--	2



SERIE 31

Tomas de corriente / Socket outlets / Prises de courant

Serie
Series
Série

Función
Function
Fonction

Ver acabados
See finishes
Voir finitions

Código
Code
Code



Base de enchufe bipolar sin tomatierra 16A - 250V~
Two-pole socket-outlet without earth contact
Prise de courant sans terre

◀ Carátula de porcelana / Porcelain cover / Tête de prise en porcelaine

31 209 -- 2

Solo reposición. Replacement only. Uniquement remplacement



Base de enchufe bipolar con tomatierra lateral 16A - 250V~
Two-pole socket-outlet with side earth contact
Prise de courant avec contact latéral de terre

◀ Carátula de porcelana / Porcelain cover / Tête de prise en porcelaine

31 212 -- 2



Base de enchufe bipolar francesa con espiga de contacto de tierra 16A - 250V~
French two-pole socket-outlet with earth pin
Prise de courant système français avec terre

◀ Carátula de porcelana / Porcelain cover / Tête de prise en porcelaine

31 208 -- 2



Acabados
Finishes
Finitions

17



27



	<p>Base de enchufe bipolar sin tomatierra Two-pole socket-outlet without earth contact Prise de courant sans terre</p> <p>16A - 250V~</p> <p>Carátula de plástico / Plastic cover / Tête de prise en plastique</p>	<p>31 209 -- 2</p>
<p>Solo reposición. Replacement only. Uniquement remplacement</p>		
	<p>Base de enchufe bipolar con tomatierra lateral Two-pole socket-outlet with side earth contact Prise de courant avec contact latéral de terre</p> <p>16A - 250V~</p> <p>Carátula de plástico / Plastic cover / Tête de prise en plastique</p>	<p>31 212 -- 2</p>
	<p>Base de enchufe bipolar francesa con espiga de contacto de tierra French two-pole socket-outlet with earth pin Prise de courant système français avec terre</p> <p>16A - 250V~</p> <p>Carátula de plástico / Plastic cover / Tête de prise en plastique</p>	<p>31 208 -- 2</p>



SERIE 31

Reguladores de luz / Dimmers / Variateurs

Serie
Series
Série

Función
Function
Fonction

Ver acabados
See finishes
Voir finitions

Código
Code
Code

Mecanismo + regulador / Mechanism + dimmer / Mécanisme + variateur



Regulador rotativo pulsación
Rotary pushbutton dimmer
Régulateur rotatif pulsation

Incandescencia - halógenas 230V~ 40-500W
Incandescent - halogen bulbs 230V~ 40-500W
Incandescence - halogènes 230V~ 40-500W

Transformador mecánico 40-500W
Mechanical transformer 40-500W
Transformateur mécanique 40-500W

31 333 -- 1

Incandescencia - halógenas 230V~ 60-900W
Incandescent - halogen bulbs 230V~ 60-900W
Incandescence - halogènes 230V~ 60-900W

Transformador mecánico 60-900W
Mechanical transformer 60-900W
Transformateur mécanique 60-900W

31 334 -- 1

LED 1-200W

31 3K8 -- 1

LED 1-100W

Incandescencia - halógenas 230V~ 1-400W
Incandescent - halogen bulbs 230V~ 1-400W
Incandescence-halogènes 230V~ 1-400W

Transformador electrónico-electromecánico 1-300W
Electronic-electromechanical transformer 1-300W
Transformateur électronique-électromécanique 1-300W

Lámparas fluorescentes compactas (CFL) 1-100W
Compact fluorescent lamps (CFL) 1-100W
Lampes fluorescentes compactes (CFL) 1-100W

31 3K9 -- 1

0-10V / 1-10V máx. 50mA

31 3L0 -- 1



Los reguladores de pulsación disponen de un dispositivo electrónico que debe ser instalado en una caja anexa al pulsador.

Pushbutton dimmers are fitted with an electronic device that must be installed in a box attached to the pushbutton.

Les variateurs à poussoir sont dotés d'un dispositif électronique qui doit être installé dans un boîtier annexe.

Acabados
Finishes
Finitions

17



27



Mecanismo + regulador / Mechanism + dimmer / Mécanisme + variateur



Regulador pulsación botón
Pushbutton dimmer
Régulateur pulsation bouton

Incandescencia - halógenas 230V~ 40-500W
Incandescent - halogen bulbs 230V~ 40-500W
Incandescence - halogènes 230V~ 40-500W

Transformador mecánico 40-500W
Mechanical transformer 40-500W
Transformateur mécanique 40-500W

31 358 -- 2

Incandescencia - halógenas 230V~ 60-900W
Incandescent - halogen bulbs 230V~ 60-900W
Incandescence - halogènes 230V~ 60-900W

Transformador mecánico 60-900W
Mechanical transformer 60-900W
Transformateur mécanique 60-900W

31 359 -- 2

LED 1-200W

31 3L4 -- 2

LED 1-100W

Incandescencia - halógenas 230V~ 1-400W
Incandescent - halogen bulbs 230V~ 1-400W
Incandescence-halogènes 230V~ 1-400W

Transformador electrónico-electromecánico 1-300W
Electronic-electromechanical transformer 1-300W
Transformateur électronique-électromécanique 1-300W

31 3L5 -- 2

Lámparas fluorescentes compactas (CFL) 1-100W
Compact fluorescent lamps (CFL) 1-100W
Lampes fluorescentes compactes (CFL) 1-100W

0-10V / 1-10V máx. 50mA

31 3L6 -- 2



Los reguladores de pulsación disponen de un dispositivo electrónico que debe ser instalado en una caja anexa al pulsador.

Pushbutton dimmers are fitted with an electronic device that must be installed in a box attached to the pushbutton.

Les variateurs à poussoir sont dotés d'un dispositif électronique qui doit être installé dans un boîtier annexe.



Serie
Series
Série

Función
Function
Fonction

Ver acabados
See finishes
Voir finitions

Código
Code
Code



Regulador-conmutador
Dimmer switch
Régulateur-commutateur

Incandescencia - halógenas 230V~ 40-500W
Incandescent - halogen bulbs 230V~ 40-500W
Incandescence - halogènes 230V~ 40-500W

Transformador mecánico 40-500W
Mechanical transformer 40-500W
Transformateur mécanique 40-500W

31

332

--

2

Regulador-conmutador universal
Universal dimmer
(two-way switch)
Régulateur (va-et-vient)
universel

LED 230V 4-100W

Incandescencia - halógenas 25-400W
Incandescent - halogen bulbs 25-400W
Incandescence - halogènes 25-400W

Transformador electrónico-electromecánico 25-400W
Electronic-electromechanical transformer 25-400W
Transformateur électronique-électromécanique 25-400W

31

330

--

2



Ver información técnica en: See technical information on: Voir informations techniques: **Pg. 192**

Acabados
Finishes
Finitions

17



27





Toma señal RTV-SAT ecualizada
R/TV and SAT equalized signal socket
Prise signal RTV-SAT égalisée

Toma única
Single socket
Prise unique

35 712 -- 2

Toma intermedia
Intermediate socket
Prise intermédiaire
A

35 713 -- 2

Toma intermedia
Intermediate socket
Prise intermédiaire
B

35 714 -- 2

Toma final
Final socket
Prise finale

35 711 -- 2



Solo tapa
Only cover
Seulement couvercle

35 715 -- 2



Ver información técnica en: See technical information on: Voir informations techniques: **Pg. 190**



SERIE 31

Tomas de voz-datos / Voice-data sockets / Prises téléphone-informatiques

Serie
Series
Série

Función
Function
Fonction

Ver acabados
See finishes
Voir finitions

Código
Code
Code



Doble toma
Double socket
Double prise

Telefonía 6 vías
Telephone 6 ways
Téléphone 6 voies

31	706	--	2
----	-----	----	---

RJ45 CAT6

31	707	--	2
----	-----	----	---

6 vías + RJ45 CAT6

31	708	--	2
----	-----	----	---



Doble toma
Double socket
Double prise

RJ45 CAT6A
apantallado
shielded
blindé

31	761	--	2
----	-----	----	---

Acabados
Finishes
Finitions





17



27



EMPOTRADA FITTING ENCASTRÉE

	Doble toma* Double socket Double prise	HDMI	31	726	--	2
	Doble toma** Double socket Double prise	HDMI + USB	31	743	--	2
	Doble toma Double socket Double prise	HDMI + RJ45 CAT6	31	728	--	2
	Doble toma** Double socket Double prise	USB Adaptador hembra-hembra Female-female adapter Adaptateur femelle-femelle	31	729	--	2
	Doble toma** Double socket Double prise	USB + RJ45 CAT6	31	719	--	2



SERIE 31

Otras funciones / Other functions / Autres fonctions

Serie
Series
Série

Función
Function
Fonction

Ver acabados
See finishes
Voir finitions

Código
Code
Code



Mecanismo para tarjetas con indicador luminoso.
Interruptor-conmutador
 Card switch with luminous indicator.
 Switch - Two way switch
 Mécanisme pour cartes avec indicateur lumineux.
 Interrupteur - Va-et-vient

1 microrruptor 6A - 250V~
 1 micro-switch
 1 microrrupteur

37 935 05 2

2 microrruptores 6A - 250V~
 2 micro-switch
 2 microrrupteurs

37 936 05 2



Ver información técnica en: See technical information on: Voir informations techniques: Pg. 188



Baliza luminosa, blanco - verde - rojo
 Luminous marker, white - green - red
 Balise lumineuse, blanche - verte - rouge

230V~

35 755 05 2

12/24V DC

35 756 05 2



Termostato para calefacción suelo radiante*
 Floor heating thermostat
 Thermostat pour chauffage sol radiant

Incluye sonda
 With sensor cable
 Avec sonde.

37 721 05 2







Termostato para calefacción temperatura ambiente *
 Room temperature thermostat
 Thermostat chauffage température ambiante

37 722 05 2



Ver información técnica en: See technical information on: Voir informations techniques: Pg. 189

* Montar con marco 31-821-.. / Mount with frame 31-821-.. / Monter avec plaque 31-821-..

	<p>Detector de presencia 180° y sonido* Presence and sound detector 180° Décteur de présence et de son a 180°</p>	37	750	05	2	
<p> Ver información técnica en: See technical information on: Voir informations techniques: Pg. 188</p>						
	<p>Mecanismo interruptor con llave Switch mechanism with key Interrupteur à clés</p>	31	906	05	2	
	<p>Altavoz para caja universal Loudspeaker for universal box Hautparleur pour boîtier standard</p>	2W 16Ω	31	926	--	2
	<p>Toma para altavoz Loudspeaker socket Prise pour hautparleur</p>	S/DIN 41429	31	905	--	2
	<p>Zumbador intermitente Buzzer intermittent Sonette intermittente</p>	220V 80 dB	31	390	--	2

* Montar con marco 31-821-.. / Mount with frame 31-821-.. / Monter avec plaque 31-821-..



Serie
Series
Série

Función
Function
Fonction

Ver acabados
See finishes
Voir finitions

Código
Code
Code



Potenciometro regulador de volumen
Potentiometer for volume regulation
Potentiomètre pour réglage du volume

31

924

--

2



Tapa ciega
Blind cover
Cache neutre

31

656

--

2



Salida de cables
Cable outlet cover
Sortie de câbles

Ø 8.5mm

31

927

--

2

Acabados
Finishes
Finitions

17



27



Serie	Func.	Acab.	Cod.	Serie	Func.	Acab.	Cod.	Serie	Func.	Acab.	Cod.	Serie	Func.	Acab.	Cod.
Series	Funct.	Finish	Code	Series	Funct.	Finish	Code	Series	Funct.	Finish	Code	Series	Funct.	Finish	Code
Serie	Fonct.	Finit.	Code	Serie	Fonct.	Finit.	Code	Serie	Fonct.	Finit.	Code	Serie	Fonct.	Finit.	Code

Madera / Wood / Bois



Haya envejecida
Aged beech
Hêtre vieilli





Haya color miel
Honey-colour beech
Hêtre couleur miel



Haya natural
Natural beech
Hêtre naturel

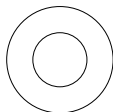
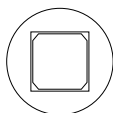

Haya sin barniz
Beech without varnish
Hêtre sans vernis

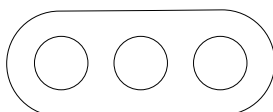
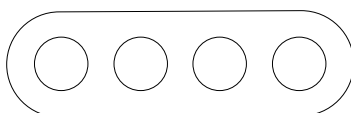
	1 elemento 1 element 1 élément	Ø 100x12mm	31	801	21	2	31	801	19	2	31	801	81	2	31	801	00	2
	Marco especial Special frame Plaque spécial	1 elemento cuadrado* 1 square element 1 élément carré	31	821	21	2	31	821	19	2	31	821	81	2	31	821	00	2
		Ø 100x12mm																
	2 elementos 2 elements 2 éléments	175x100x12mm	31	802	21	2	31	802	19	2	31	802	81	2	31	802	00	2
	3 elementos 3 elements 3 éléments	246x100x12mm	31	803	21	2	31	803	19	2	31	803	81	2	31	803	00	2
	4 elementos 4 elements 4 éléments	318x100x12mm	31	804	21	2	31	804	19	2	31	804	81	2	31	804	00	2

(*) A usar con referencias 37 721..., 37 722..., 37 750... / To use with references 37 721..., 37 722..., 37 750... / A utiliser avec les références 37 721..., 37 722..., 37 750...

Serie	Func.	Acab.	Cod.	Serie	Func.	Acab.	Cod.	Serie	Func.	Acab.	Cod.	Serie	Func.	Acab.	Cod.
Series	Funct.	Finish	Code	Series	Funct.	Finish	Code	Series	Funct.	Finish	Code	Series	Funct.	Finish	Code
Serie	Fonct.	Finit.	Code	Serie	Fonct.	Finit.	Code	Serie	Fonct.	Finit.	Code	Serie	Fonct.	Finit.	Code

Porcelana / Porcelain / Porcelaine



Porcelana blanca
White porcelain
Porcelaine blanche



Porcelana negra
Black porcelain
Porcelaine noire







Porcelana decor
Decor porcelain
Porcelaine décor



Porcelana craquelé
Craquelé porcelain
Porcelaine craquelé

	1 elemento 1 element 1 élément	Ø 100x12mm	31	801	17	2	31	801	27	2	31	801	61	2	31	801	09	2
	Marco especial Special frame Plaque spécial	1 elemento cuadrado* 1 square element 1 élément carré	31	821	17	2	31	821	27	2	31	821	61	2	31	821	09	2
		Ø 100x12mm																
	2 elementos 2 elements 2 éléments	175x100x12mm	31	802	17	2	31	802	27	2	31	802	61	2	31	802	09	2
	3 elementos 3 elements 3 éléments	246x100x12mm	31	803	17	2	31	803	27	2	31	803	61	2	31	803	09	2

(*) A usar con referencias 37 721..., 37 722..., 37 750... / To use with references 37 721..., 37 722..., 37 750... / A utiliser avec les références 37 721..., 37 722..., 37 750...

	Caja de empalmes Wall connection box Boîte de dérivation		86x86x40mm*	37	400	51	2
	Caja de empalmes Wall connection box Boîte de dérivation		86x160x40mm*	37	399	51	2
	Caja de empalmes Wall connection box Boîte de dérivation	Rectangular Rectangular Rectangulaire	175x125x500mm	30	402	51	2
	Caja de superficie metal envejecido Aged metal surface box for Boîte saillie métal vieilli	2 elementos 2 elements 2 éléments	Instalación horizontal Horizontal installation Installation horizontale	35	408	22	2
				Instalación vertical Vertical installation Installation verticale	35	409	22
	Caja de superficie níquel satinado Nickel-plated surface box for Boîte saillie nickel satiné	2 elementos 2 elements 2 éléments	Instalación horizontal Horizontal installation Installation horizontale	35	408	51	2
				Instalación vertical Vertical installation Installation verticale	35	409	51

*1 agujero de entrada 16mm; para más agujeros, consultar / 1 hole 16mm; for more holes, please contact us / 1 entrée de tube 16mm; pour plusieurs entrées, contactez-nous.





EMPOTRADA FITTING ENCASTRÉE

VENEZIA

Collection

Mecanismos / Mechanisms / Mécanismes

Serie 65 (pg. 123)

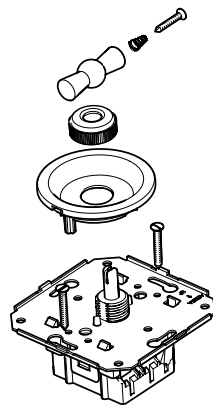
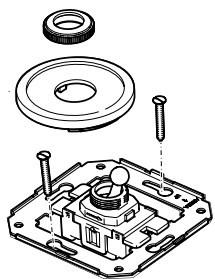

Serie 35 (pg. 128)



Marcos / Frames / Plaques (pg. 140)

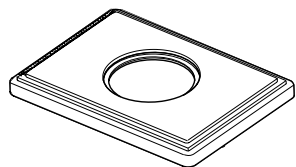

-
- Instalación empotrada
 - Mecanismos de 10AX 250V~
 - Bases de enchufe de 16A 250V~
 - Contactos de plata de alto poder de ruptura
 - Marcos de madera, latón y porcelana
 - Marcos para instalar en posición vertical u horizontal
 - Instalación en caja universal con tornillos

-
- Fitting installation
 - 10AX 250V~ mechanisms
 - 16A 250V~ sockets
 - Silver contacts with high breaking power
 - Wooden, brass & porcelain frames
 - Frames for vertical or horizontal installations
 - Installation in standard box with screws

-
- Installation encastrée
 - Mécanismes de 10AX 250V~
 - Prises de courant 16A 250V~
 - Contacts en argent avec haut pouvoir de rupture
 - Plaques en bois, laiton et porcelaine
 - Plaques pour installation verticale ou horizontale
 - Installation sur boîte standard avec vis
-



30

Manecilla dorada - Carátula blanca
Golden knob - White cover
Manette dorée - Couvercle blanche



59

Manecilla patiné americano - Carátula blanca
Antique bronze knob - White cover
Manette bronze ancien - Couvercle blanche



26

Manecilla cromo brillo - Carátula blanca
Polished chrome knob - White cover
Manette chrome brillant - Couvercle blanche



54

Manecilla dorada - Carátula marrón
Golden knob - Brown cover
Manette dorée - Couvercle marron



57

Manecilla patiné americano - Carátula marrón
Antique bronze knob - Brown cover
Manette bronze ancien - Couvercle marron



52

Manecilla cromo brillo - Carátula marrón
Polished chrome knob - Brown cover
Manette chrome brillant - Couvercle marron

SERIE 65. TOGGLE SWITCHES

Mecanismos / Mechanisms / Mécanismes

Serie
Series
Série

Función
Function
Fonction

Ver acabados
See finishes
Voir finitions

Código
Code
Code



Interruptor unipolar
Single pole switch
Interrupteur unipolaire

10AX - 250V~

65

306

--

1

Conmutador
Two-way switch
Va-et-vient

10AX - 250V~

65

308

--

1

Cruzamiento
Intermediate switch
Permutateur

10AX - 250V~

65

304

--

1

Interruptor bipolar
Double pole switch
Interrupteur bipolaire

10AX - 250V~

65

314

--

1

Acabados
Finishes
Finitions

30



59



26



54



57



52



EMPOTRADA FITTING ENCASTRÉE



Doble interruptor
Double switch
Double interrupteur

10AX - 250V~

65

300

--

2

Doble conmutador
Double two-way switch
Double va-et-vient

10AX - 250V~

65

302

--

2



SERIE 65. TOGGLE SWITCHES

Pulsadores / Pushbuttons / Poussoirs

Serie
Series
Série

Función
Function
Fonction

Ver acabados
See finishes
Voir finitions

Código
Code
Code



Pulsador de manecilla
Toggle pushbutton
Bouton poussoir

10A - 250V
24V DC

65

312

--

2



Doble pulsador de manecilla
Double toggle pushbutton
Double bouton poussoir

10A - 250V~
24V DC

65

345

--

2



Doble pulsador para persianas
(para motores de 1,66A)
Double pushbutton for blinds
(for 1.66A motors)
Double poussoir pour volets
(pour moteurs 1,66A)

10A - 250V~

65

342

--

2

Acabados
Finishes
Finitions

30



59



26



54



57



52





30

Manecilla dorada - Carátula blanca
Golden knob - White cover
Manette dorée - Couvercle blanc



16

Manecilla haya color miel - Carátula blanca
Honey-colour beech knob - White cover
Manette hêtre couleur miel - Couvercle blanc



17

Manecilla porcelana blanca - Carátula blanca
White porcelain knob - White cover
Manette porcelaine blanche - Couvercle blanc



59

Manecilla patiné americano - Carátula blanca
Antique bronze knob - White cover
Manette bronze ancien - Couvercle blanc



25

Manecilla níquel satinado - Carátula blanca
Satin nickel knob - White cover
Manette nickel satiné - Couvercle blanc



23

Manecilla porcelana retro blanca - Carátula blanca
Retro white porcelain knob - White cover
Manette porcelaine rétro blanche - Couvercle blanc



54

Manecilla dorada - Carátula marrón
Golden key - Brown cover
Manette dorée - Couvercle marron



57

Manecilla patiné americano - Carátula marrón
Antique bronze knob - Brown cover
Manette bronze ancien - Couvercle marron



52

Manecilla níquel satinado - Carátula marrón
Satin nickel knob - Brown cover
Manette nickel satiné - Couvercle marron



Interruptor unipolar
Single pole switch
Interrupteur unipolaire

10AX - 250V~

35

306

--

2

Conmutador
Two-way switch
Va-et-vient

10AX - 250V~

35

308

--

2

Cruzamiento
Intermediate switch
Permutateur

10AX - 250V~

35

304

--

2

Interruptor bipolar
Double pole switch
Interrupteur bipolaire

10AX - 250V~

35

314

--

2

**Mecanismo para persianas
(para motores de 1,66A)**
Electric blinds mechanism
(for 1.66A motors)
Mécanisme pour volets roulants
(pour moteurs 1,66A)

10A - 250V~

35

342

--

2

Acabados
Finishes
Finitions

30



16



17



59



25



23



54



57



52



Serie
Series
Série

Función
Function
Fonction

Ver acabados
See finishes
Voir finitions

Código
Code
Code



Doble interruptor
Double switch
Double interrupteur

10AX - 250V~

35

300

--

2

Doble conmutador
Double two-way switch
Double va-et-vient

10AX - 250V~

35

302

--

2

Acabados
Finishes
Finitions

30



16



17



59



25



23



54









57

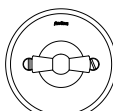
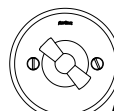
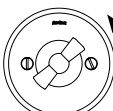

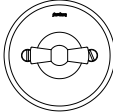
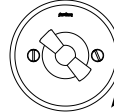
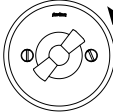
52



	<p>Pulsador rotativo Rotary pushbutton switch Bouton rotatif</p> <p>10AX - 250V~</p> <p>SALIDA / OUTPUT / SORTIE</p>	<p>Posición de reposo Rest position Position de repos</p>  OFF  ON  ON	<table border="1"> <tr> <td>35</td> <td>328</td> <td>--</td> <td>2</td> </tr> </table>	35	328	--	2
35	328	--	2				
	<p>Doble pulsador rotativo Double rotary pushbutton switch Double bouton rotatif</p> <p>10AX - 250V~</p> <p>SALIDA / OUTPUT / SORTIE</p>	<p>Posición de reposo Rest position Position de repos</p>  OFF  ON 1  ON 2	<table border="1"> <tr> <td>35</td> <td>344</td> <td>--</td> <td>2</td> </tr> </table>	35	344	--	2
35	344	--	2				
	<p>Pulsador de botón Pushbutton Bouton poussoir</p>	<p>10AX - 250V~ 24V DC</p>	<table border="1"> <tr> <td>35</td> <td>310</td> <td>--</td> <td>2</td> </tr> </table> <p>Acabados: Finishes: Finitions: 30-25-59-54-57-52-26-58</p>	35	310	--	2
35	310	--	2				
	<p>Pulsador temporizador * Timer pushbutton Bouton poussoir temporisateur</p> <p>*30seg a 10min. Incandescencia y halógenas 30 sec. to 10 min. Incandescent and halogen 30 sec. à 10 min. Incandescence et halogène.</p>	<p>10AX - 250V~</p>	<table border="1"> <tr> <td>35</td> <td>316</td> <td>--</td> <td>2</td> </tr> </table> <p>Acabados: Finishes: Finitions: 30-25-59-54-57-52-26-58</p>	35	316	--	2
35	316	--	2				
	<p>Doble pulsador de botón Double pushbutton Double bouton poussoir</p>	<p>10AX - 250V~ 24V DC</p>	<table border="1"> <tr> <td>35</td> <td>343</td> <td>--</td> <td>2</td> </tr> </table> <p>Acabados: Finishes: Finitions: 30-25-59-54-57-52-26-58</p>	35	343	--	2
35	343	--	2				

SERIE 35. ROTARY SWITCHES

Tomas de corriente / Socket outlets / Prises de courant

Serie
Series
Série

Función
Function
Fonction

Ver acabados
See finishes
Voir finitions

Código
Code
Code



Base de enchufe bipolar sin tomatierra
Two-pole socket-outlet without earth contact
Prise de courant sans terre

16A - 250V~

35

209

--

2

Solo reposición. Replacement only. Uniquement remplacement



Base de enchufe bipolar con tomatierra lateral
Two-pole socket-outlet with side earth contact
Prise de courant avec contact latéral de terre

16A - 250V~

35

212

--

2



Base de enchufe bipolar francesa con espiga de contacto de tierra
French two-pole socket-outlet with earth pin
Prise de courant système français avec terre

16A - 250V~

35

208

--

2

Acabados
Finishes
Finitions

05



03





Regulador-conmutador
Dimmer switch
Régulateur-commutateur

Incandescencia - halógenas 230V~ 40-500W
Incandescent - halogen bulbs 230V~ 40-500W
Incandescence - halogènes 230V~ 40-500W

Transformador mecánico 40-500W
Mechanical transformer 40-500W
Transformateur mécanique 40-500W

35

332

--

2

Regulador-conmutador universal
Universal dimmer
(two-way switch)
Régulateur (va-et-vient)
universal

LED 230V 4-100W

Incandescencia - halógenas 25-400W
Incandescent - halogen bulbs 25-400W
Incandescence - halogènes 25-400W

Transformador electrónico-electromecánico 25-400W
Electronic-electromechanical transformer 25-400W
Transformateur électronique-électromécanique 25-400W

35

330

--

2



Ver información técnica en: See technical information on: Voir informations techniques: **Pg. 192**



SERIE 35. ROTARY SWITCHES

Tomas de televisión / Television sockets / Prises télévision

Serie
Series
Série

Función
Function
Fonction

Ver acabados
See finishes
Voir finitions

Código
Code
Code



Toma señal RTV-SAT ecualizada
R/TV and SAT equalized signal socket
Prise signal RTV-SAT égalisée

Toma única
Single socket
Prise unique

35	712	--	2
----	-----	----	---

Toma intermedia
Intermediate socket
Prise intermédiaire
A

35	713	--	2
----	-----	----	---

Toma intermedia
Intermediate socket
Prise intermédiaire
B

35	714	--	2
----	-----	----	---

Toma final
Final socket
Prise finale

35	711	--	2
----	-----	----	---



Solo tapa
Only cover
Seulement couvercle

35	715	--	2
----	-----	----	---



Ver información técnica en: See technical information on: Voir informations techniques: **Pg. 190**

Acabados
Finishes
Finitions

05



03



SERIE 35. ROTARY SWITCHES

Tomas de voz-datos / Voice-data sockets / Prises téléphone-informatiques

Serie
Series
Série

Función
Function
Fonction

Ver acabados
See finishes
Voir finitions

Código
Code
Code



Doble toma
Double socket
Double prise

Telefonía 6 vías
Telephone 6 ways
Téléphone 6 voies

35

706

--

2

RJ45 CAT6

35

707

--

2

6 vías + RJ45 CAT6

35

708

--

2



Doble toma
Double socket
Double prise

RJ45 CAT6A
apantallado
shielded
blindé

35

761

--

2

Acabados
Finishes
Finitions

05



03



SERIE 35. ROTARY SWITCHES

Tomas multimedia / Multimedia sockets / Prises multimédia

Serie
Series
Série

Función
Function
Fonction

Ver acabados
See finishes
Voir finitions

Código
Code
Code



Doble toma
Double socket
Double prise

HDMI

35

726

--

2



Doble toma*
Double socket
Double prise

HDMI + USB

35

743

--

2



Doble toma
Double socket
Double prise

HDMI + RJ45 CAT6

35

728

--

2

Acabados
Finishes
Finitions

05





03



* Las tomas USB no son cargadores USB / USB sockets are not charging sockets / USB prise n'est pas un chargeur USB

EMPOTRADA FITTING ENCASTRÉE

	<p>Doble toma* Double socket Double prise</p>	<p>USB Adaptador hembra-hembra Female-female adapter Adaptateur femelle-femelle</p>	<table border="1"> <tr> <td>35</td> <td>729</td> <td>--</td> <td>2</td> </tr> </table>	35	729	--	2
35	729	--	2				
	<p>Doble toma* Double socket Double prise</p>	<p>USB+RJ45 CAT6</p>	<table border="1"> <tr> <td>35</td> <td>719</td> <td>--</td> <td>2</td> </tr> </table>	35	719	--	2
35	719	--	2				
	<p>Toma audio Audio socket Prise audio</p>	<p>RCA</p>	<table border="1"> <tr> <td>37</td> <td>907</td> <td>--</td> <td>2</td> </tr> </table>	37	907	--	2
37	907	--	2				

* Las tomas USB no son cargadores USB / USB sockets are not charging sockets / USB prise n'est pas un chargeur USB



SERIE 35. ROTARY SWITCHES

Otras funciones / Other functions / Autres fonctions

Serie
Series
Série

Función
Function
Fonction

Ver acabados
See finishes
Voir finitions

Código
Code
Code

	<p>Mecanismo para tarjetas con indicador luminoso. Interruptor-conmutador Card switch with luminous indicator. Switch - Two way switch Mécanisme pour cartes avec indicateur lumineux. Interrupteur - Va-et-vient</p>	<p>1 microrruptor 6A - 250V~ 1 micro-switch 1 microrrupteur</p>	37	935	--	2
		<p>2 microrruptores 6A - 250V~ 2 micro-switch 2 microrrupteurs</p>	37	936	--	2
	<p>Baliza luminosa, blanco - verde - rojo Luminous marker, white - green - red Balise lumineuse, blanche - verte - rouge</p>	230V~	35	755	--	2
		12/24V DC	35	756	--	2
	<p>Termostato para calefacción suelo radiante.* Floor heating thermostat. Thermostat pour chauffage sol radiant.</p>	<p>Incluye sonda With sensor cable Avec sonde.</p>	37	721	05	2
	<p>Termostato para calefacción temperatura ambiente * Room temperature thermostat Thermostat chauffage température ambiante</p>		37	722	05	2



Ver información técnica en: See technical information on: Voir informations techniques: Pg. 189

Acabados
Finishes
Finitions

05



03



* Montar con marco 35-821-../ Mount with frame 35-821-../ Monter avec plaque 35-821-..

	<p>Detector de presencia 180° y sonido* Presence and sound detector 180° Détecteur de présence et son 180°</p>	37	750	--	2	
<p> Ver información técnica en: See technical information on: Voir informations techniques: Pg. 188</p>						
	<p>Mecanismo interruptor con llave Switch mechanism with key Interrupteur à clés</p>	35	906	--	2	
	<p>Altavoz para caja universal Loudspeaker for universal box Hautparleur pour boîtier standard</p>	2W 16Ω	35	926	--	2
	<p>Toma para altavoz Loudspeaker socket Prise pour hautparleur</p>	S/DIN 41429	35	905	--	2
	<p>Zumbador intermitente Buzzer intermittent Sonette intermittente</p>	220V 80 dB	35	390	--	2

* Montar con marco 35-821-.. / Mount with frame 35-821-.. / Monter avec plaque 35-821-..



Serie
Series
Série

Función
Function
Fonction

Ver acabados
See finishes
Voir finitions

Código
Code
Code



Salida de cables
Cable outlet cover
Sortie de câbles

35 927 - 2

Acabados: Finishes: Finitions: 30-59-25-54-57-52-26-58



Tapa ciega
Blind cover
Couvercle aveugle

35 656 -- 2



Adaptador para controles de sonido
Adaptor for sound control
Adaptateur pour contrôles de son

EGI®

37 944 -- 2



Adaptador para controles de sonido
Adaptor for sound control
Adaptateur pour contrôles de son

TEZ® y Sonbel®

37 945 -- 2



Potenciómetro regulador de volumen
Potentiometer for volume regulation
Potentiomètre pour réglage du volume

35 924 -- 2

Acabados
Finishes
Finitions

05



03



30



59



26



54



57



52



26



58



Serie	Func.	Acab.	Cod.	Serie	Func.	Acab.	Cod.	Serie	Func.	Acab.	Cod.
Series	Funct.	Finish	Code	Series	Funct.	Finish	Code	Series	Funct.	Finish	Code
Serie	Fonct.	Finít.	Code	Serie	Fonct.	Finít.	Code	Serie	Fonct.	Finít.	Code

Madera / Wood / Bois



Haya color nogal
Beech walnut colored
Hêtre couleur noyer



Sapelly
Sapelly
Sapelly



Haya color roble
Beech oak colored
Hêtre couleur chêne

	1 elemento 1 element 1 élément	125x85x13mm	35	801	20	2	35	801	16	2	35	801	15	2
	Marco especial Special frame Plaque spécial	1 elemento cuadrado* 1 square element 1 élément carré	35	821	20	2	35	821	16	2	35	821	15	2
	2 elementos 2 elements 2 éléments	190x85x13mm	35	802	20	2	35	802	16	2	35	802	15	2
	3 elementos 3 elements 3 éléments	261x85x13mm	35	803	20	2	35	803	16	2	35	803	15	2
	4 elementos 4 elements 4 éléments	333x85x13mm	35	804	20	2	35	804	16	2	35	804	15	2

(*) A usar con refs. 37 721.., 37 722.., 37 750..

CLÁSICA

Marcos / Frames / Plaques

Madera / Wood / Bois



Haya sin barniz
Beech without varnish
Hêtre sans vernis



Haya lacado blanco
Beech white lacquered
Hêtre laqué blanc



Sapelly
Sapelly
Sapelly

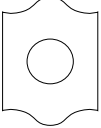
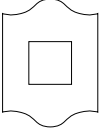
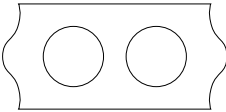
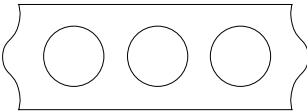
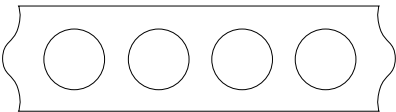

Haya sin barniz
Beech without varnish
Hêtre sans vernis

Serie	Func.	Acab.	Cod.	Serie	Func.	Acab.	Cod.	Dimension	Serie	Func.	Acab.	Cod.	Serie	Func.	Acab.	Cod.
Series	Funct.	Finish	Code	Series	Funct.	Finish	Code		Series	Funct.	Finish	Code	Series	Funct.	Finish	Code
Series	Fonct.	Finit.	Code	Series	Fonct.	Finit.	Code		Series	Fonct.	Finit.	Code	Series	Fonct.	Finit.	Code
35	801	00	2	35	801	05	2	 110x85x12mm	36	801	16	2	36	801	00	2
35	821	00	2	35	821	05	2	 110x85x12mm	36	821	16	2	36	821	00	2
35	802	00	2	35	802	05	2	 181x85x12mm	36	802	16	2	36	802	00	2
35	803	00	2	35	803	05	2	 253x85x12mm	36	803	16	2	36	803	00	2
35	804	00	2	35	804	05	2	 253x85x12mm	36	804	16	2	36	804	00	2

Madera / Wood / Bois



Sapelly
Sapelly
Sapelly



Haya sin barniz
Beech without varnish
Hêtre sans vernis

		1 elemento 1 element 1 élément	90x90x12mm	36	811	16	2	36	811	00	2
	Marco especial Special frame Plaque spécial	1 elemento cuadrado* 1 square element 1 élément carré	90x90x12mm	36	831	16	2	36	831	00	2
		2 elementos 2 elements 2 éléments	175x90x12mm	36	812	16	2	36	812	00	2
		3 elementos 3 elements 3 éléments	245x90x12mm	36	813	16	2	36	813	00	2
		4 elementos 4 elements 4 éléments	316x90x12mm	36	814	16	2	36	814	00	2

(*) A usar con refs. 37 721.., 37 722.., 37 750..

METAL

Marcos / Frames / Plaques

Serie	Func.	Acab.	Cod.	Serie	Func.	Acab.	Cod.	Serie	Func.	Acab.	Cod.
Series	Funct.	Finish	Code	Series	Funct.	Finish	Code	Series	Funct.	Finish	Code
Serie	Fonct.	Finit.	Code	Serie	Fonct.	Finit.	Code	Serie	Fonct.	Finit.	Code

Latón / Brass / Laiton



Dorado
Golden
Doré

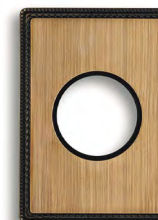

Patiné americano
Antique bronze
Bronze ancien

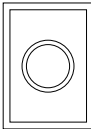
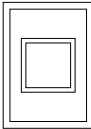
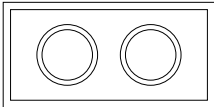
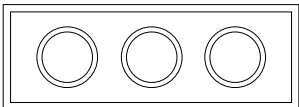
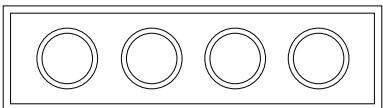

Níquel satinado
Satin nickel-plated
Nickel satiné

	1 elemento 1 element 1 élément	125x91x12mm	39	801	50	2	39	801	53	2	39	801	51	2
	Marco especial Special frame Plaque spécial	1 elemento cuadrado* 1 square element 1 élément carré	39	821	50	2	39	821	53	2	39	821	51	2
	2 elementos 2 elements 2 éléments	181x91x12mm	39	802	50	2	39	802	53	2	39	802	51	2
	3 elementos 3 elements 3 éléments	253x91x12mm	39	803	50	2	39	803	53	2	39	803	51	2
	4 elementos 4 elements 4 éléments	324x91x12mm	39	804	50	2	39	804	53	2	39	804	51	2

Serie	Func.	Acab.	Cod.	Serie	Func.	Acab.	Cod.	Serie	Func.	Acab.	Cod.	Serie	Func.	Acab.	Cod.
Series	Funct.	Finish	Code	Series	Funct.	Finish	Code	Series	Funct.	Finish	Code	Series	Funct.	Finish	Code
Serie	Fonct.	Finit.	Code	Serie	Fonct.	Finit.	Code	Serie	Fonct.	Finit.	Code	Serie	Fonct.	Finit.	Code

Madera / Wood / Bois



Haya envejecida
Aged beech
Hêtre vieilli



Haya color miel
Honey-colour beech
Hêtre couleur miel



Haya natural
Natural beech
Hêtre naturel

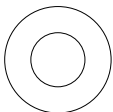
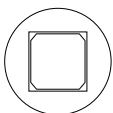
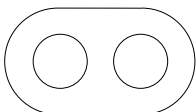
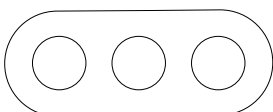
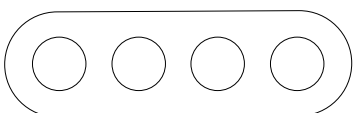

Haya sin barniz
Beech without varnish
Hêtre sans vernis

	1 elemento 1 element 1 élément	Ø 100x12mm	31	801	21	2	31	801	19	2	31	801	81	2	31	801	00	2
	Marco especial Special frame Plaque spécial	1 elemento cuadrado* 1 square element 1 élément carré	31	821	21	2	31	821	19	2	31	821	81	2	31	821	00	2
		Ø 100x12mm																
	2 elementos 2 elements 2 éléments	175x100x12mm	31	802	21	2	31	802	19	2	31	802	81	2	31	802	00	2
	3 elementos 3 elements 3 éléments	246x100x12mm	31	803	21	2	31	803	19	2	31	803	81	2	31	803	00	2
	4 elementos 4 elements 4 éléments	318x100x12mm	31	804	21	2	31	804	19	2	31	804	81	2	31	804	00	2

Serie	Func.	Acab.	Cod.	Serie	Func.	Acab.	Cod.	Serie	Func.	Acab.	Cod.	Serie	Func.	Acab.	Cod.
Series	Funct.	Finish	Code	Series	Funct.	Finish	Code	Series	Funct.	Finish	Code	Series	Funct.	Finish	Code
Serie	Fonct.	Finit.	Code	Serie	Fonct.	Finit.	Code	Serie	Fonct.	Finit.	Code	Serie	Fonct.	Finit.	Code

Porcelana / Porcelain / Porcelaine



Porcelana blanca
White porcelain
Porcelaine blanche



Porcelana negra
Black porcelain
Porcelaine noire







Porcelana decor
Decor porcelain
Porcelaine décor

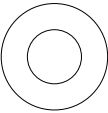
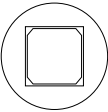
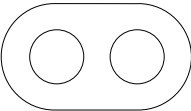
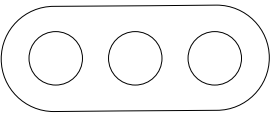

Porcelana craquelé
Craquelé porcelain
Porcelaine craquelé

	1 elemento 1 element 1 élément	Ø 100x12mm	31	801	17	2	31	801	27	2	31	801	61	2	31	801	09	2
	Marco especial Special frame Plaque spécial	1 elemento cuadrado* 1 square element 1 élément carré	31	821	17	2	31	821	27	2	31	821	61	2	31	821	09	2
		Ø 100x12mm																
	2 elementos 2 elements 2 éléments	175x100x12mm	31	802	17	2	31	802	27	2	31	802	61	2	31	802	09	2
	3 elementos 3 elements 3 éléments	246x100x12mm	31	803	17	2	31	803	27	2	31	803	61	2	31	803	09	2





	Caja de empalmes Wall connection box Boîte de dérivation		86x86x40mm*	37	400	51	2
	Caja de empalmes Wall connection box Boîte de dérivation		86x160x40mm*	37	399	51	2
	Caja de empalmes Wall connection box Boîte de dérivation	Rectangular Rectangular Rectangulaire	175x125x500mm	30	402	51	2
	Caja de superficie metal envejecido Aged metal surface box for Boîte saillie métal vieilli	2 elementos 2 elements 2 éléments	instalación horizontal horizontal installation installation horizontale	35	408	22	2
			instalación vertical vertical installation installation verticale	35	409	22	2
	Caja de superficie níquel satinado Nickel-plated surface box for Boîte saillie nickel satiné	2 elementos 2 elements 2 éléments	instalación horizontal horizontal installation installation horizontale	35	408	51	2
			instalación vertical vertical installation installation verticale	35	409	51	2

*1 agujero de entrada 16mm; para más agujeros, consultar / 1 hole 16mm; for more holes, please contact us / 1 entrée de tube 16mm; pour plusieurs entrées, contactez-nous.

SERIE 65/35

Regulador pulsación botón / Pushbutton dimmer / Régulateur pulsation bouton

Serie Series Série	Función Function Fonction	Acabado Finish Finition	Código Code Code
--------------------------	---------------------------------	-------------------------------	------------------------

	<p>Incandescencia - halógenas 230V~ 40-500W Incandescent - halogen bulbs 230V~ 40-500W Incandescence - halogènes 230V~ 40-500W</p> <p>Transformador mecánico 40-500W Mechanical transformer 40-500W Transformateur mécanique 40-500W</p>	51x42x15mm	37	346	00	0
	<p>Incandescencia - halógenas 230V~ 60-900W Incandescent - halogen bulbs 230V~ 60-900W Incandescence - halogènes 230V~ 60-900W</p> <p>Transformador mecánico 60-900W Mechanical transformer 60-900W Transformateur mécanique 60-900W</p>	51x51x29mm	37	347	00	0
	<p>LED 1-200W</p>	53x51x23mm	37	365	00	0
	<p>LED 1-100W Incandescencia - halógenas 230V~ 1-400W Incandescent - halogen bulbs 230V~ 1-400W Incandescence-halogènes 230V~ 1-400W</p> <p>Transformador electrónico-electromecánico 1-300W Electronic-electromechanical transformer 1-300W Transformateur électronique-électromécanique 1-300W</p> <p>Lámparas fluorescentes compactas (CFL) 1-100W Compact fluorescent lamps (CFL) 1-100W Lampes fluorescentes compactes (CFL) 1-100W</p>	47x42x21mm	37	371	00	0
	<p>0-10V / 1-10V máx. 50mA</p>	54x52x23mm	37	372	00	0



F37 Collection

Mecanismos / Mechanisms / Mécanismes

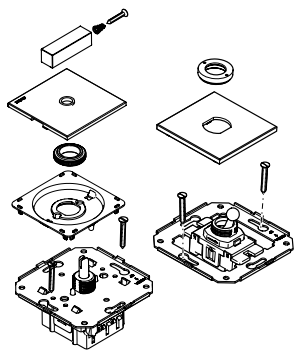

Serie 67 (pg. 154)



Serie 37 (pg. 160)



Marcos / Frames / Plaques (pg. 172)

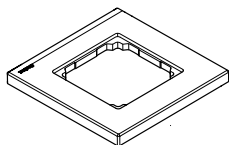

-
- Instalación empotrada
 - Mecanismos de 10AX 250V~
 - Bases de enchufe de 16A 250V~
 - Contactos de plata de alto poder de ruptura
 - Marcos de madera maciza de fresno y latón
 - Marcos para instalar en posición vertical u horizontal
 - Instalación en caja universal con tornillos

-
- Fitting installation
 - 10AX 250V~ mechanisms
 - 16A 250V~ sockets
 - Silver contacts with high breaking power
 - Massif ashtrée wood frames and brass
 - Frames for vertical or horizontal installations
 - Installation in standard box with screws

-
- Installation encastrée
 - Mécanismes de 10AX 250V~
 - Prises de courant 16A 250V~
 - Contacts en argent avec haut pouvoir de rupture
 - Plaques en bois massif frêne et laiton
 - Plaques pour installation verticale ou horizontale
 - Installation sur boîte standard avec vis
-

F37
Collection



SERIE 67. TOGGLE SWITCHES
Acabados / Finishes / Finitions



26

Manecilla cromo brillo - Carátula blanca
Polished chrome knob - White cover
Manette chromé brillante - Couvercle blanc



61

Manecilla cromo brillo - Carátula metalizada
Polished chrome knob - Metallic cover
Manette chromé brillante - Couvercle métallisé



54

Manecilla dorada - Carátula marrón
Golden knob - Brown cover
Manette dorée - Couvercle marron



57

Manecilla patiné americano - Carátula marrón
Antique bronze knob - Brown cover
Manette bronze ancien - Couvercle marron



Interruptor unipolar
Single pole switch
Interrupteur unipolaire

10AX - 250V~

67

306

--

2

Conmutador
Two-way switch
Va-et-vient

10AX - 250V~

67

308

--

2

Cruzamiento
Intermediate switch
Permutateur

10AX - 250V~

67

304

--

2

Interruptor bipolar
Double pole switch
Interrupteur bipolaire

10AX - 250V~

67

314

--

2



Doble interruptor
Double switch
Double interrupteur

10AX - 250V~

67

300

--

2

Doble conmutador
Double two-way switch
Double va-et-vient

10AX - 250V~

67

302

--

2



SERIE 67. TOGGLE SWITCHES

Pulsadores / Pushbuttons / Poussoirs

Serie
Series
Série

Función
Function
Fonction

Ver acabados
See finishes
Voir finitions

Código
Code
Code



Pulsador de manecilla
Toggle pushbutton
Bouton poussoir à manette

10A - 250V
24V DC

67

312

--

2



Doble pulsador de manecilla
Double toggle pushbutton
Double poussoir à manette

10A - 250V~
24V DC

67

345

--

2



**Doble pulsador para persianas
(para motores de 1,66A)**
Double pushbutton for blinds
(for 1.66A motors)
Double poussoir pour volets
(pour moteurs 1,66A)

10A - 250V~
24V DC

67

342

--

2

Acabados
Finishes
Finitions

26



61



54



57



F37

Collection



SERIE 37. ROTARY SWITCHES

Acabados / Finishes / Finitions



25

Manecilla acero inoxidable - Carátula blanca
Stainless steel knob - White cover
Manette acier inoxydable - Couvercle blanc



51

Manecilla acero inoxidable - Carátula metalizada
Stainless steel knob - Metallic cover
Manette acier inoxydable - Couvercle métallisé



54

Manecilla dorada - Carátula marrón
Golden knob - Brown cover
Manette dorée - Couvercle marron



57

Manecilla patiné americano - Carátula marrón
Antique bronze knob - Brown cover
Manette bronze ancien - Couvercle marron



Interruptor unipolar
Single pole switch
Interrupteur unipolaire

10AX - 250V~

37

306

--

2

Conmutador
Two-way switch
Va-et-vient

10AX - 250V~

37

308

--

2

Cruzamiento
Intermediate switch
Permutateur

10AX - 250V~

37

304

--

2

Interruptor bipolar
Double pole switch
Interrupteur bipolaire

10AX - 250V~

37

314

--

2

**Mecanismo para persianas
(para motores de 1,66A)**
Electric blinds mechanism
(for 1.66A motors)
Mécanisme pour volets roulants
(pour moteurs 1,66A)

10A - 250V~

37

342

--

2



Serie
Series
Série

Función
Function
Fonction

Ver acabados
See finishes
Voir finitions

Código
Code
Code



Doble interruptor
Double switch
Double interrupteur

10AX - 250V~

37

300

--

2

Doble conmutador
Double two-way switch
Double va-et-vient

10AX - 250V~

37

302

--

2

Acabados
Finishes
Finitions

25



51



54



57



	<p>Pulsador rotativo Rotary pushbutton switch Poussoir rotatif</p>	<p>10AX - 250V~</p>	<p>SALIDA / OUTPUT / SORTIE</p>	<p>Posición de reposo Rest position Position de repos</p>		<p>37</p>	<p>328</p>	<p>25 51 54 57</p>	<p>2</p>
	<p>Doble pulsador rotativo Double rotary pushbutton switch Double poussoir rotatif</p>	<p>10AX - 250V~</p>	<p>SALIDA / OUTPUT / SORTIE</p>	<p>Posición de reposo Rest position Position de repos</p>		<p>37</p>	<p>344</p>	<p>25 51 54 57</p>	<p>2</p>
	<p>Pulsador de botón Pushbutton Bouton poussoir</p>	<p>10AX - 250V~ 24V DC</p>				<p>37</p>	<p>310</p>	<p>25 51 54 57 26 61</p>	<p>2</p>
	<p>Doble pulsador de botón Double pushbutton Double bouton poussoir</p>	<p>10AX - 250V~ 24V DC</p>				<p>37</p>	<p>343</p>	<p>25 51 54 57 26 61</p>	<p>2</p>
	<p>Pulsador temporizador¹ Pushbutton timer-switch Poussoir temporisateur</p>	<p>10AX - 250V~</p>				<p>37</p>	<p>316</p>	<p>25 51 54 57 26 61</p>	<p>2</p>
	<p>¹*30seg a 10min. Incandescencia y halógenas 30 sec. to 10 min. Incandescent and halogen 30 sec. à 10 min. Incandescence et halogène.</p>								

SERIE 37. ROTARY SWITCHES

Tomas de corriente / Socket outlets / Prises de courant

Serie
Series
Série

Función
Function
Fonction

Ver acabados
See finishes
Voir finitions

Código
Code
Code



Base de enchufe bipolar sin tomatierra
Two-pole socket-outlet without earth contact
Prise de courant sans terre

16A - 250V~

37

209

--

2

Solo reposición. Replacement only. Uniquement remplacement



Base de enchufe bipolar con tomatierra lateral
Two-pole socket-outlet with side earth contact
Prise de courant avec contact latéral de terre

16A - 250V~

37

212

--

2



Base de enchufe bipolar francesa con espiga de contacto de tierra
French two-pole socket-outlet with earth pin
Prise de courant système français avec terre

16A - 250V~

37

208

--

2

Acabados
Finishes
Finitions

03



05



50





Regulador-conmutador
Dimmer switch
Régulateur-commutateur

Incandescencia - halógenas 230V~ 40-500W
Incandescent - halogen bulbs 230V~ 40-500W
Incandescence - halogènes 230V~ 40-500W

Transformador mecánico 40-500W
Mechanical transformer 40-500W
Transformateur mécanique 40-500W

37

332

--

2

Regulador-conmutador universal
Universal dimmer
(two-way switch)
Régulateur (va-et-vient)
universal

LED 230V 4-100W

Incandescencia - halógenas 25-400W
Incandescent - halogen bulbs 25-400W
Incandescence - halogènes 25-400W

Transformador electrónico-electromecánico 25-400W
Electronic-electromechanical transformer 25-400W
Transformateur électronique-électromécanique 25-400W

37

330

--

2



Ver información técnica en: See technical information on: Voir informations techniques: **Pg. 192**



SERIE 37. ROTARY SWITCHES

Tomas de televisión / Television sockets / Prises télévision

Serie
Series
Série

Función
Function
Fonction

Ver acabados
See finishes
Voir finitions

Código
Code
Code



Toma señal RTV-SAT ecualizada
R/TV and SAT equalized signal socket
Prise signal RTV-SAT égalisée

Toma única
Single socket
Prise unique

37 712 -- 2

Toma intermedia
Intermediate socket
Prise intermédiaire
A

37 713 -- 2

Toma intermedia
Intermediate socket
Prise intermédiaire
B

37 714 -- 2

Toma final
Final socket
Prise finale

37 711 -- 2



Solo tapa
Only cover
Seulement couvercle

37 715 -- 2



Ver información técnica en: See technical information on: Voir informations techniques: **Pg. 190**

Acabados
Finishes
Finitions

03



05



50





Doble toma
Double socket
Double prise

Telefonía 6 vías
Telephone 6 ways
Téléphone 6 voies

37	706	--	2
----	-----	----	---

RJ45 CAT6

37	707	--	2
----	-----	----	---

6 vías + RJ45 CAT6

37	708	--	2
----	-----	----	---



Doble toma
Double socket
Double prise

RJ45 CAT6A
apantallado
shielded
blindé

37	761	--	2
----	-----	----	---



SERIE 37. ROTARY SWITCHES

Tomas multimedia / Multimedia sockets / Prises multimédia

Serie
Series
Série

Función
Function
Fonction

Ver acabados
See finishes
Voir finitions

Código
Code
Code



Doble toma
Double socket
Double prise

HDMI

37

726

--

2



Doble toma*
Double socket
Double prise

HDMI + USB

37

743

--

2



Doble toma
Double socket
Double prise

HDMI + RJ45 CAT6

37

728

--

2

Acabados
Finishes
Finitions

03



05



50



* Las tomas USB no son cargadores USB / USB sockets are not charging sockets / USB prise n'est pas un chargeur USB

EMPOTRADA FITTING ENCASTRÉE

F37

Collection

SERIE 37. ROTARY SWITCHES

Tomas multimedia / Multimedia sockets / Prises multimédia

Serie Series Série	Función Function Fonction	Ver acabados See finishes Voir finitions	Código Code Code
--------------------------	---------------------------------	------------------------------------------------	------------------------

	<p>Doble toma* Double socket Double prise</p>	<p>USB Adaptador hembra-hembra Female-female adapter Adaptateur femelle-femelle</p>	37	729	--	2
	<p>Doble toma* Double socket Double prise</p>	<p>USB+RJ45 CAT6</p>	37	719	--	2
	<p>Doble toma Double socket Double prise</p>	<p>RCA</p>	37	907	--	2

Acabados
Finishes
Finitions

03



05



50



* Las tomas USB no son cargadores USB / USB sockets are not charging sockets / USB prise n'est pas un chargeur USB

SERIE 37. ROTARY SWITCHES

Otras funciones / Other functions / Autres fonctions

Serie
Series
Série

Función
Function
Fonction

Ver acabados
See finishes
Voir finitions

Código
Code
Code



Mecanismo para tarjetas con indicador luminoso.
Interruptor-conmutador
Card switch with luminous indicator.
Switch - Two way switch
Mécanisme pour cartes avec indicateur lumineux.
Interrupteur - Va-et-vient

1 microrruptor 6A - 250V~
1 micro-switch
1 microrrupteur

37 935 -- 2

2 microrruptores 6A - 250V~
2 micro-switch
2 microrrupteurs

37 936 -- 2



Baliza luminosa, blanco - verde - rojo
Luminous marker, white - green - red
Balise lumineuse, blanche - verte - rouge

230V~

37 755 -- 2

12/24V DC

35 756 -- 2



Termostato para calefacción suelo radiante
Floor heating thermostat
Thermostat pour chauffage sol radiant

Incluye sonda
With sensor cable
Avec sonde.

37 721 05 2

Termostato para calefacción temperatura ambiente
Room temperature thermostat
Thermostat chauffage température ambiante

37 722 05 2



Ver información técnica en: See technical information on: Voir informations techniques: Pg. 187

Acabados
Finishes
Finitions

03



05



50





Detector de presencia 180° y sonido
Presence and sound detector 180°
Détecteur de présence et son 180°

37

750

--

2



Ver información técnica en: See technical information on: Voir informations techniques: Pg. 186



Altavoz para caja universal
Loudspeaker for universal box
Hautparleur pour boîtier standard

2W 16Ω

37

926

--

2



Toma para altavoz
Loudspeaker socket
Prise pour hautparleur

S/DIN 41429

37

905

--

2



Zumbador intermitente
Buzzer intermittent
Sonette intermittente

220V 80 dB

37

390

--

2



Salida de cables
Cable outlet cover
Sortie de câbles

Ø 8mm

37

927

--

2







Serie
Series
Série

Función
Function
Fonction

Ver acabados
See finishes
Voir finitions

Código
Code
Code

	<p>Tapa ciega Blind cover Couvercle aveugle</p>			<p>03 05 50</p>	<p>2</p>
	<p>Adaptador para controles de sonido Adaptor for sound control Adaptateur pour contrôles de son</p>	<p>EGI®</p>		<p>05 10</p>	<p>2</p>
	<p>Adaptador para controles de sonido Adaptor for sound control Adaptateur pour contrôles de son</p>	<p>TEZ® y Sonbel®</p>		<p>05 10</p>	<p>2</p>
	<p>Potenciómetro regulador de volumen Potentiometer for volume regulation Potentiomètre pour réglage du volume</p>			<p>--</p>	<p>2</p>

Acabados
Finishes
Finitions

03



05



50



25



51



54



57



26



61



F37

Collection

Marcos / Frames / Plaques

Serie	Func.	Acab.	Cod.	Serie	Func.	Acab.	Cod.	Serie	Func.	Acab.	Cod.
Series	Funct.	Finish	Code	Series	Funct.	Finish	Code	Series	Funct.	Finish	Code
Serie	Fonct.	Finit.	Code	Serie	Fonct.	Finit.	Code	Serie	Fonct.	Finit.	Code

Madera / Wood / Bois



Fresno acabado wengué
Ash finished wenge
Frêne fini wengé

Fresno acabado tabaco
Ash finished tobacco
Frêne fini tabac

Fresno acabado cerezo
Ash finished cherry tree
Frêne fini merisier

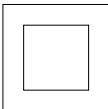
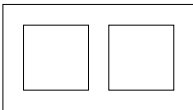
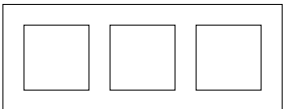
	1 elemento 1 element 1 élément	90x90x11mm	37	801	04	2	37	801	03	2	37	801	02	2
	2 elementos 2 elements 2 éléments	90x162x11mm	37	802	04	2	37	802	03	2	37	802	02	2
	3 elementos 3 elements 3 éléments	90x233x11mm	37	803	04	2	37	803	03	2	37	803	02	2

Serie	Func.	Acab.	Cod.	Serie	Func.	Acab.	Cod.	Serie	Func.	Acab.	Cod.
Series	Funct.	Finish	Code	Series	Funct.	Finish	Code	Series	Funct.	Finish	Code
Serie	Fonct.	Finit.	Code	Serie	Fonct.	Finit.	Code	Serie	Fonct.	Finit.	Code

Latón / Brass / Laiton



Dorado
Golden
Doré



Patiné americano
Antique bronze
Bronze ancien

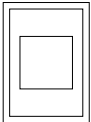
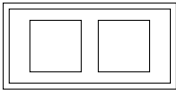
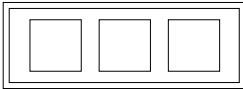
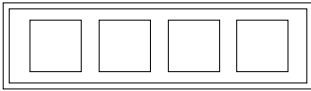

Níquel satinado
Satin nickel-plated
Nickel satiné

	1 elemento 1 element 1 élément	125x91x12mm	39	821	50	2	39	821	53	2	39	821	51	2
	2 elementos 2 elements 2 éléments	181x91x12mm	39	822	50	2	39	822	53	2	39	822	51	2
	3 elementos 3 elements 3 éléments	253x91x12mm	39	823	50	2	39	823	53	2	39	823	51	2
	4 elementos 4 elements 4 éléments	324x91x12mm	39	824	50	2	39	824	53	2	39	824	51	2

COMPLEMENTOS COMPLEMENTS COMPLÉMENTS

Serie
Series
Série

Función
Function
Fonction

Acabado
Finishes
Finitions

Código
Code
Code



Pulsador timbre
Pushbutton switch
Bouton poussoir

10A - 250V~

Pack 25 uds.

14

310

50

2



Pulsador timbre
Pushbutton switch
Bouton poussoir

10A - 250V~

Pack 25 uds.

14

310

51

2



Pulsador timbre
Pushbutton switch
Bouton poussoir

10A - 250V~

Pack 1 ud.

14

010

02

2

14

010

50

2

14

010

51

2

Acabados
Finishes
Finitions

02

Negro
Black
Noir

50

Dorado
Golden
Doré

51

Niquelado
Nickel-plated
Niquelé

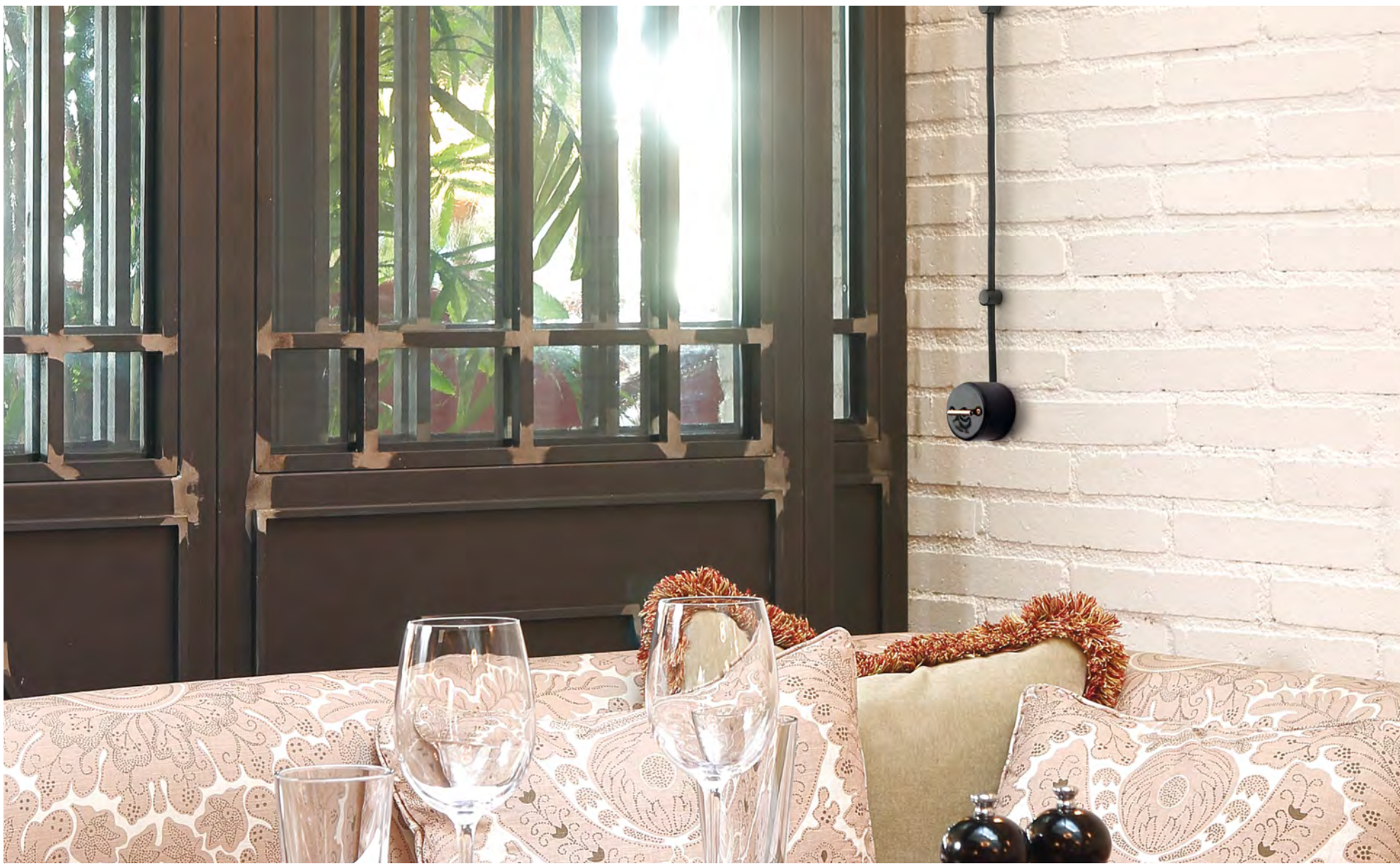



Tipos de Instalación / Types of installation / Types d'installation

GARBY / DIMBLER

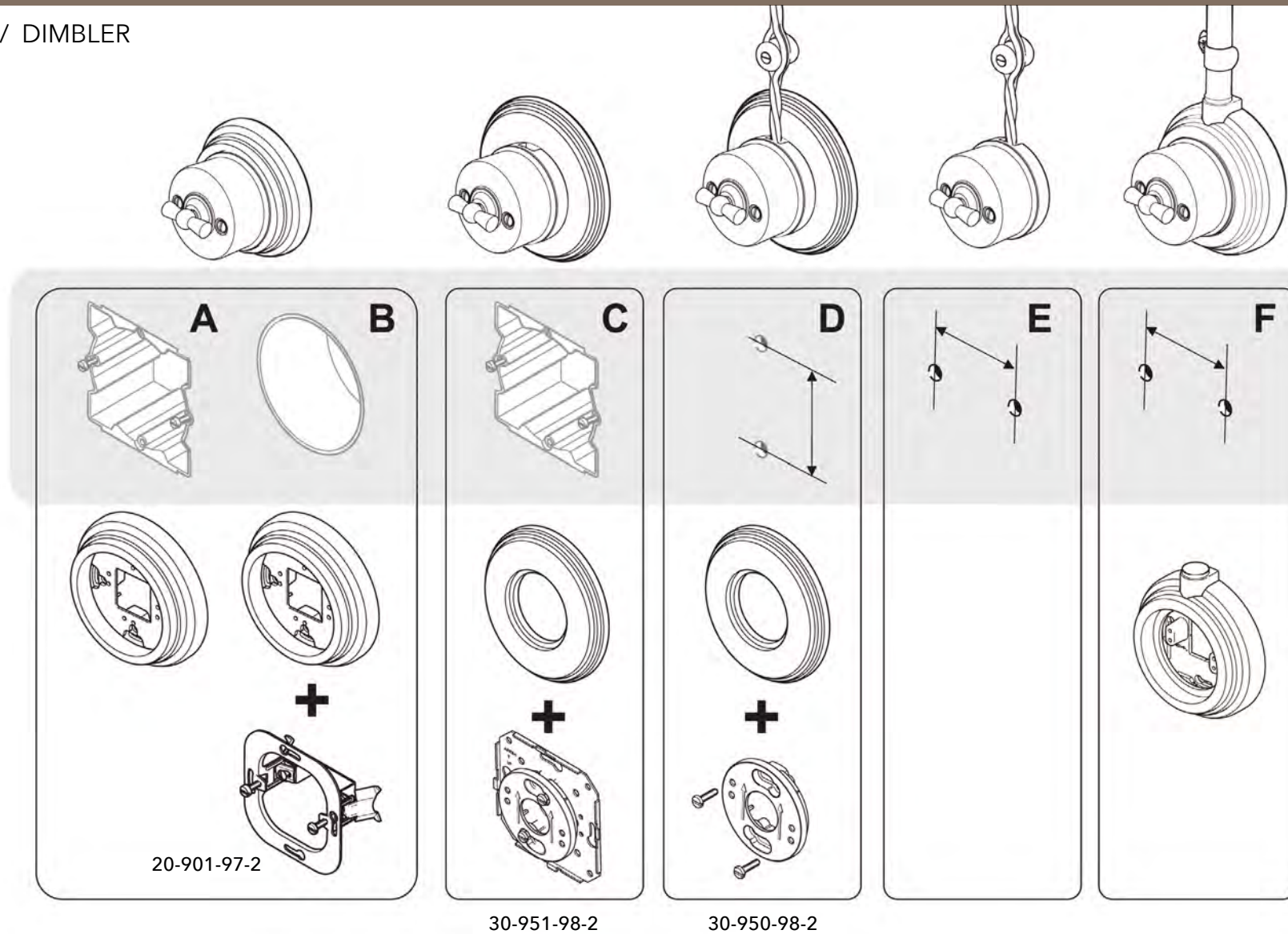

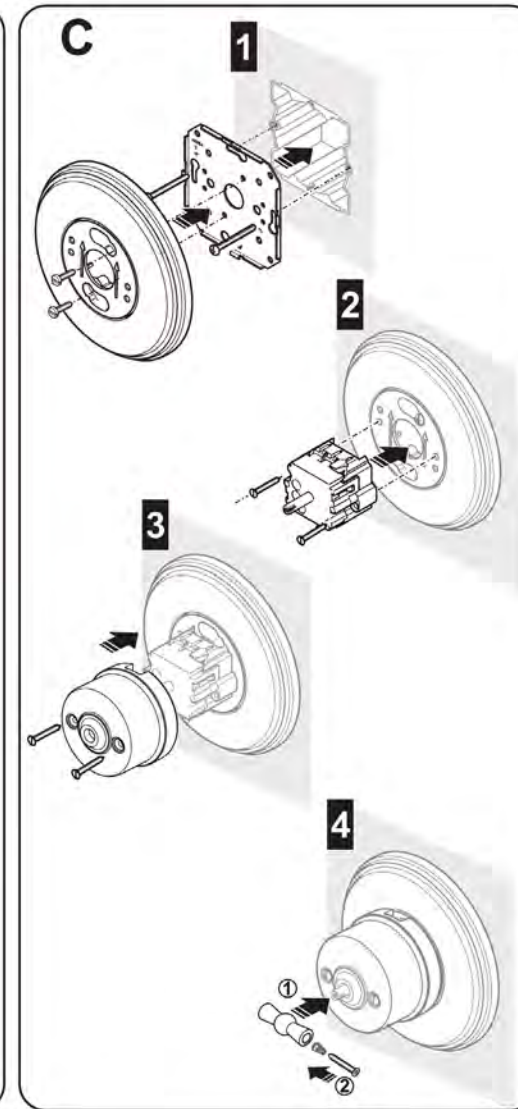
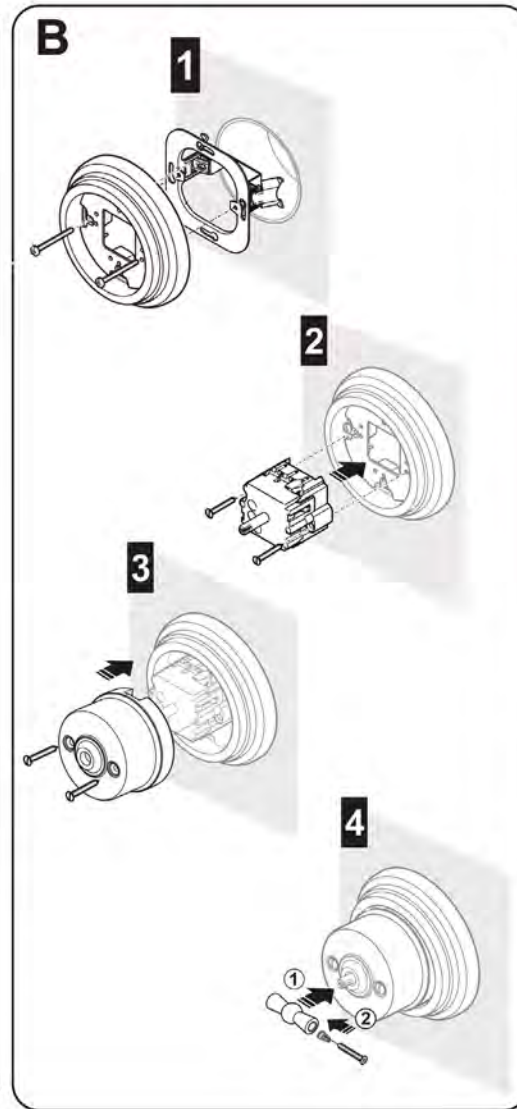
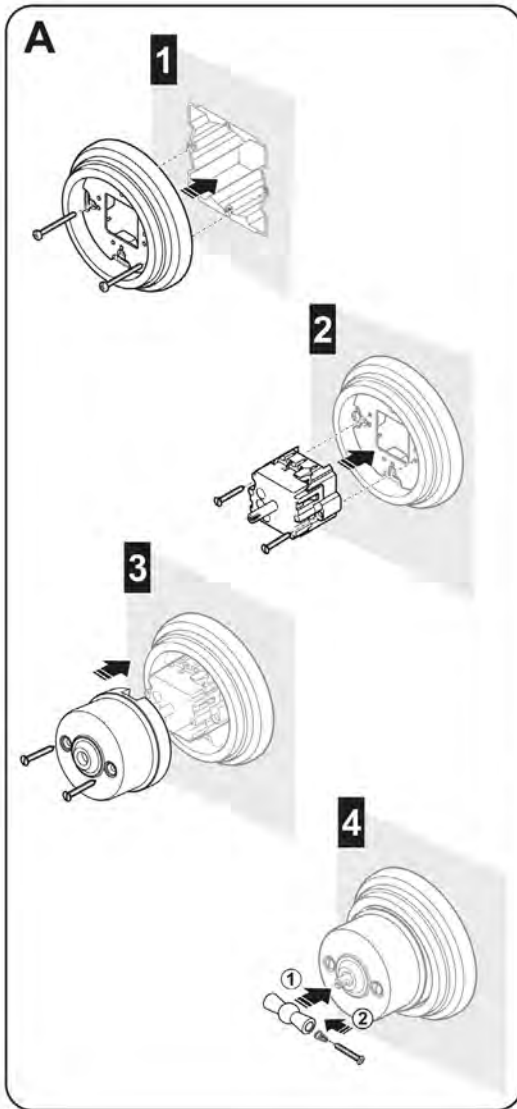

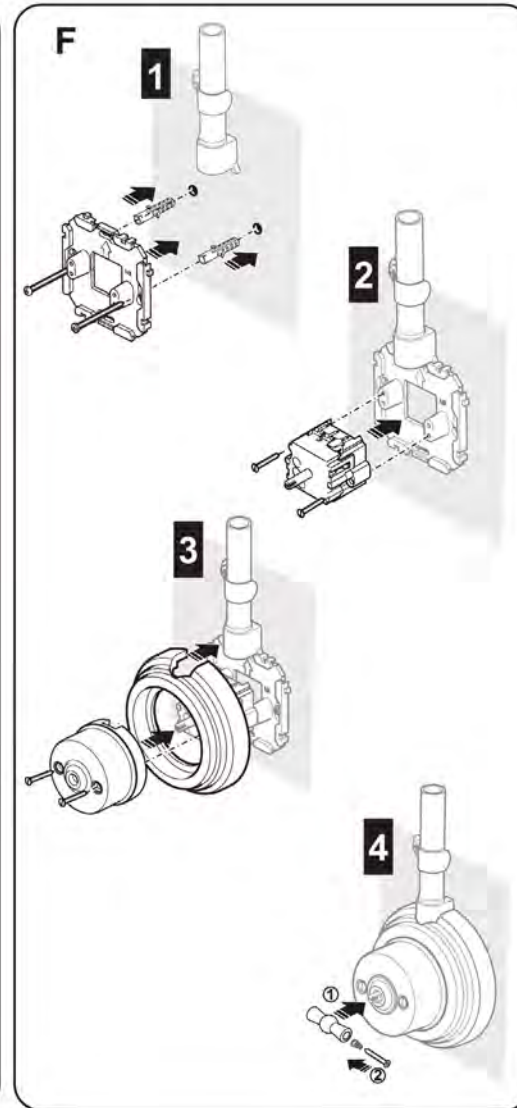
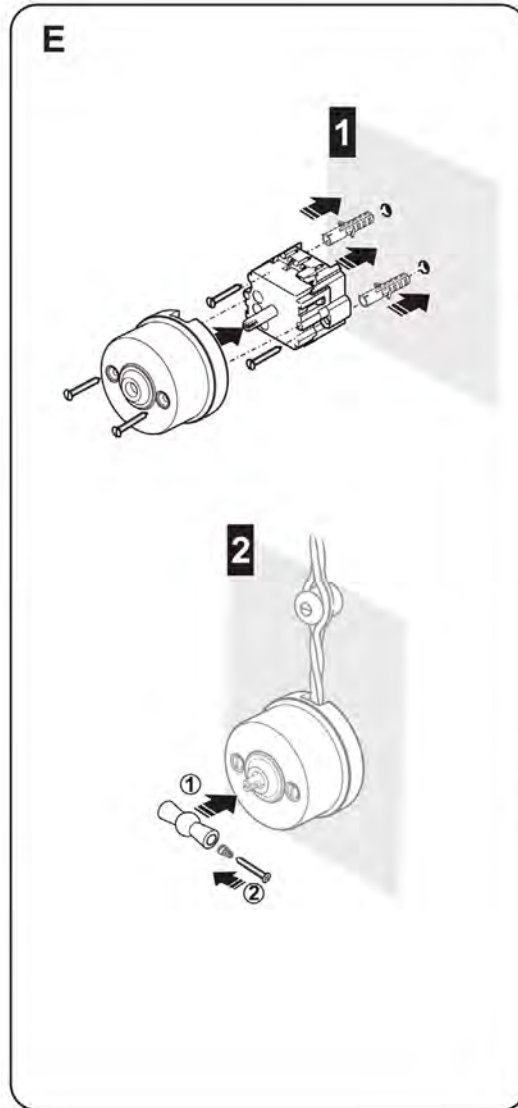
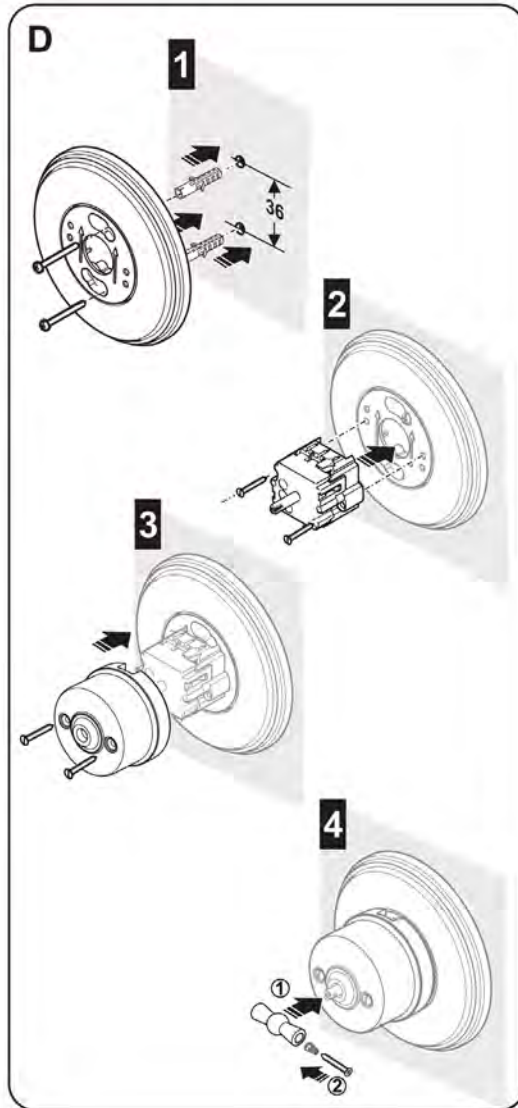

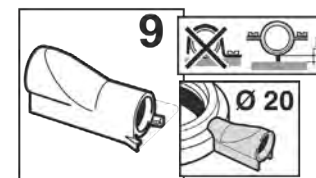
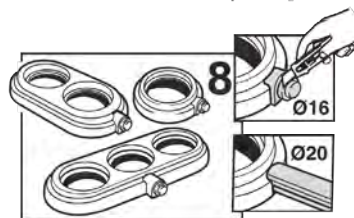
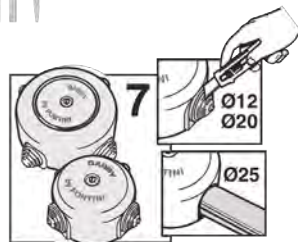
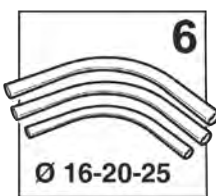
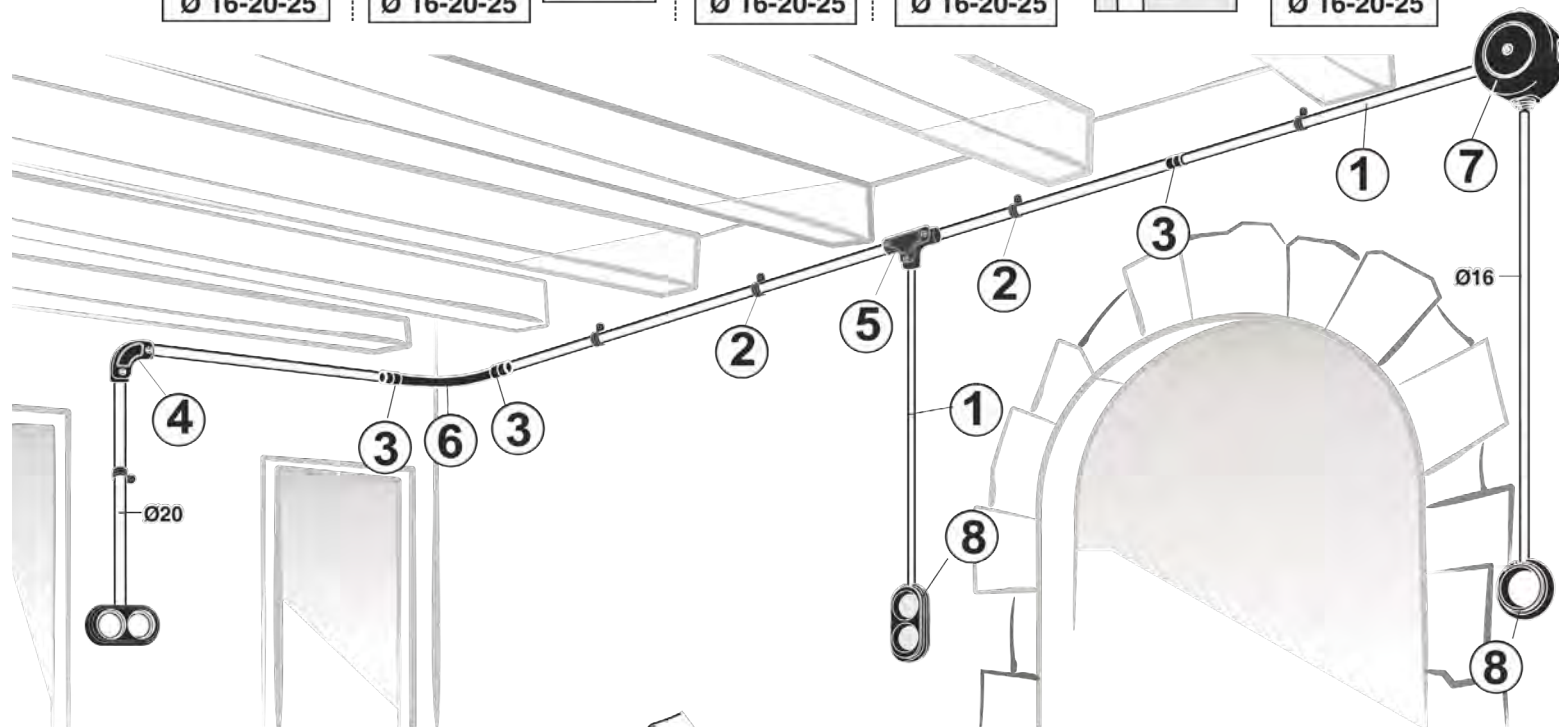
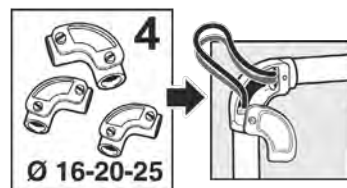
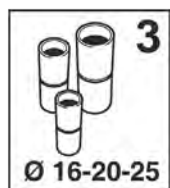
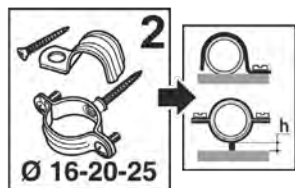

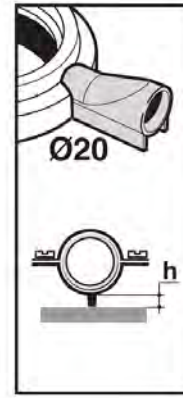
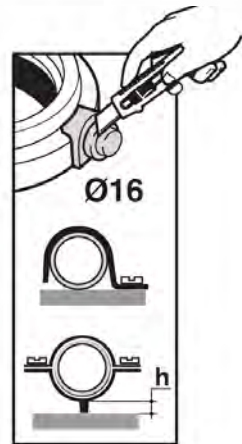
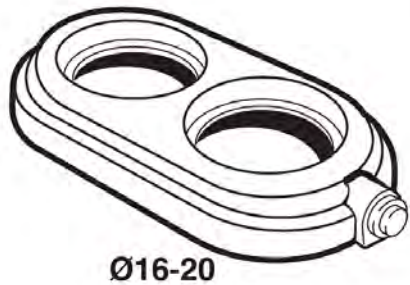
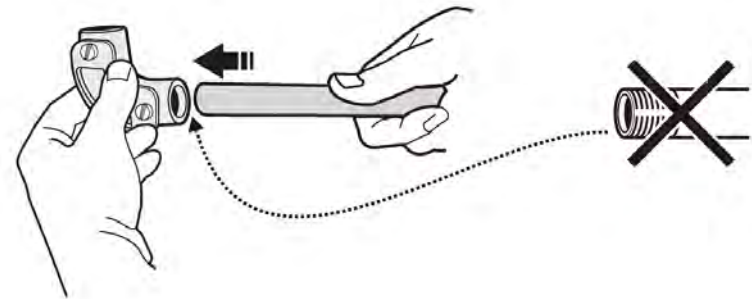
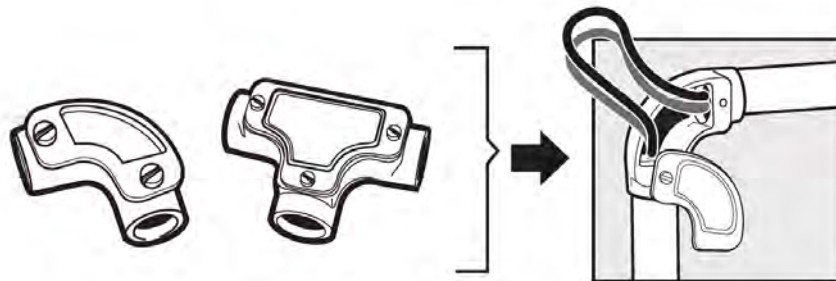
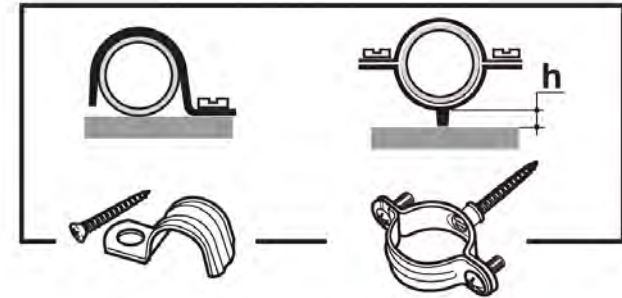
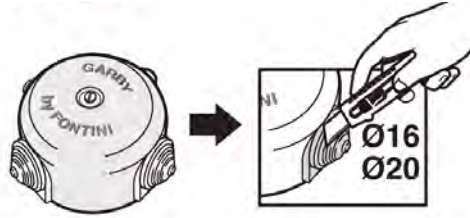
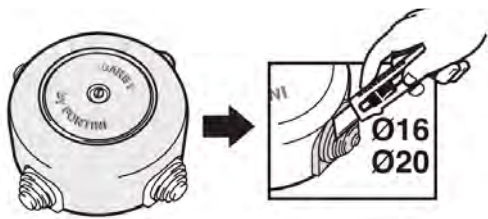

Tipos de Instalación / Types of installation / Types d'installation

DO

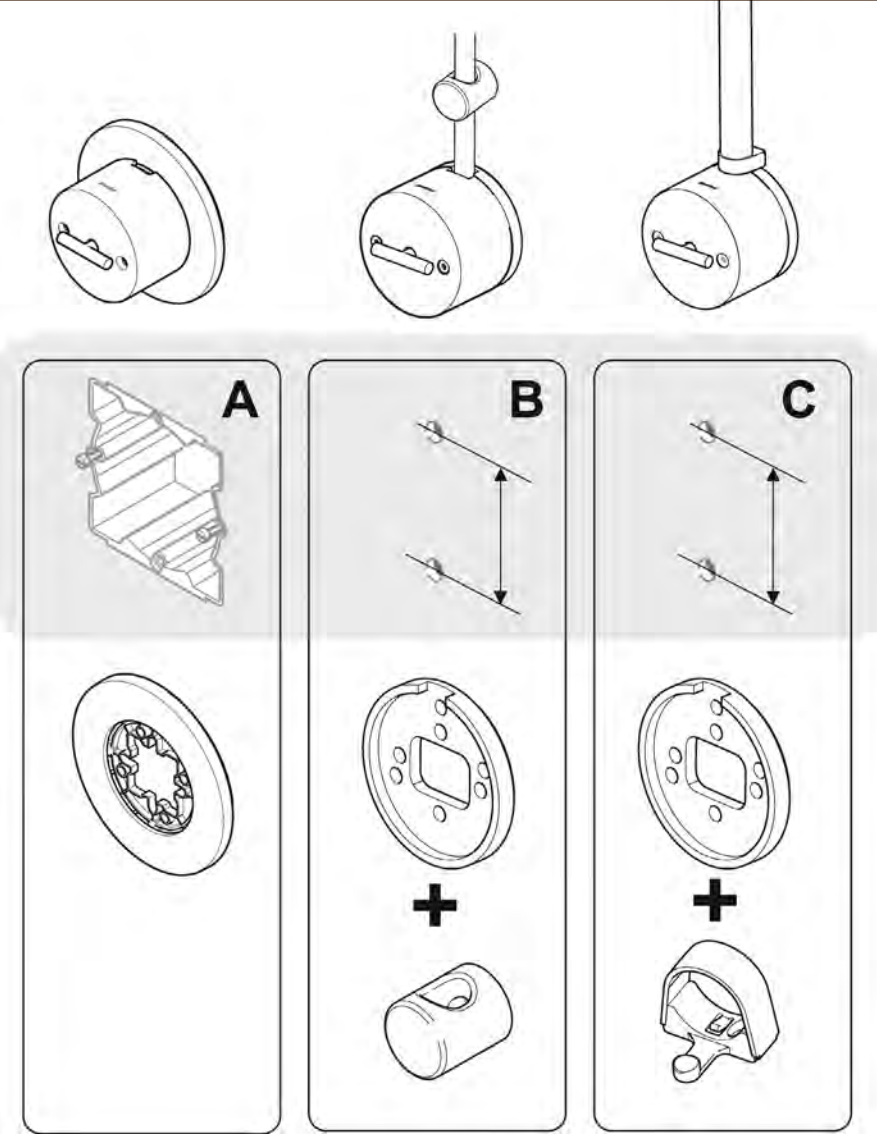

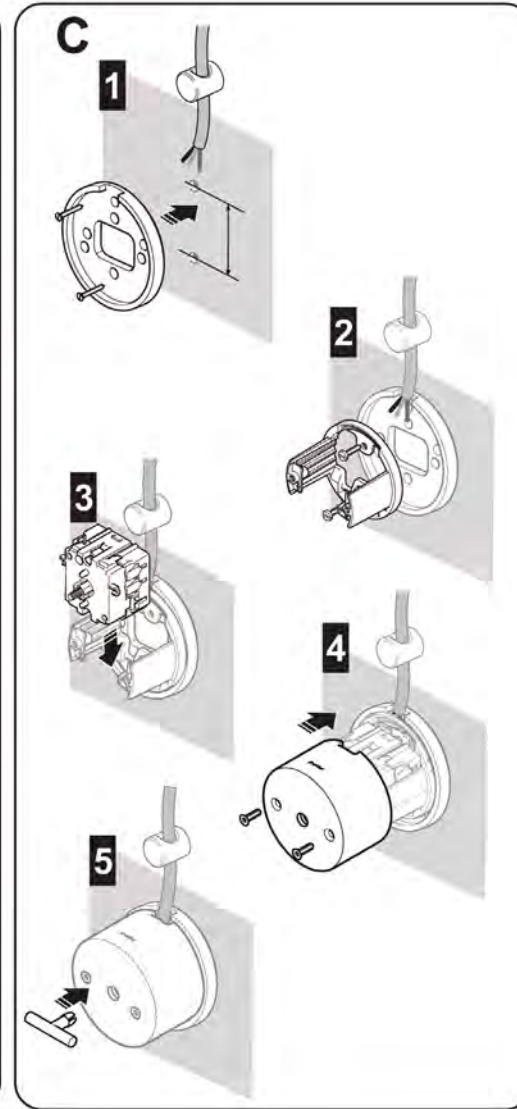
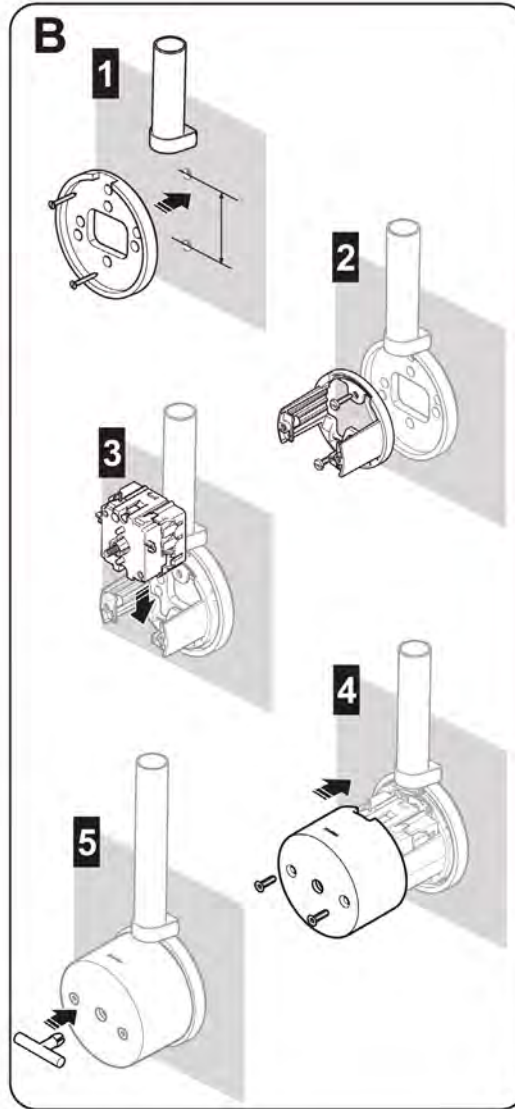
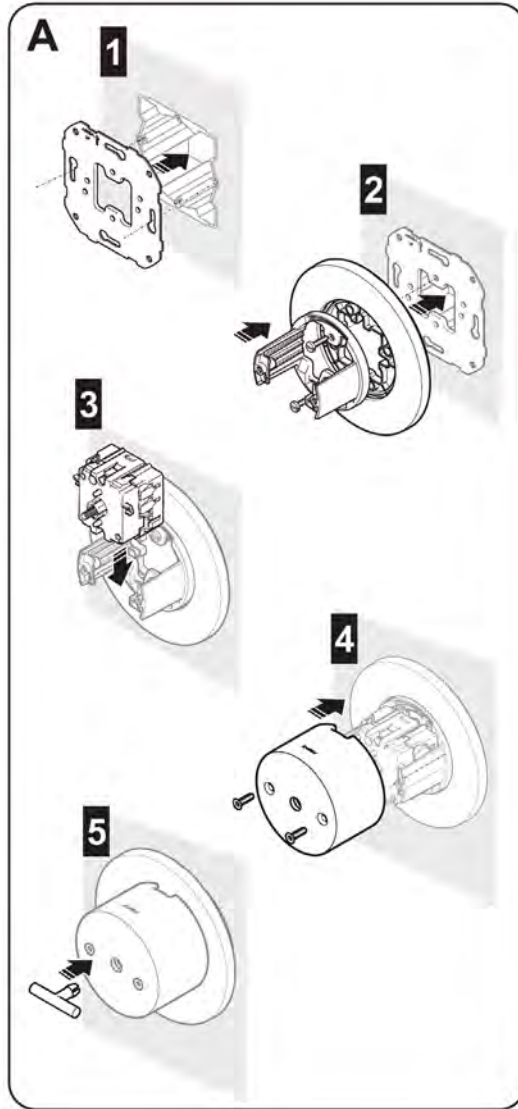

Tipos de Instalación / Types of installation / Types d'installation

VENEZIA / GARBY COLONIAL / DO / F37

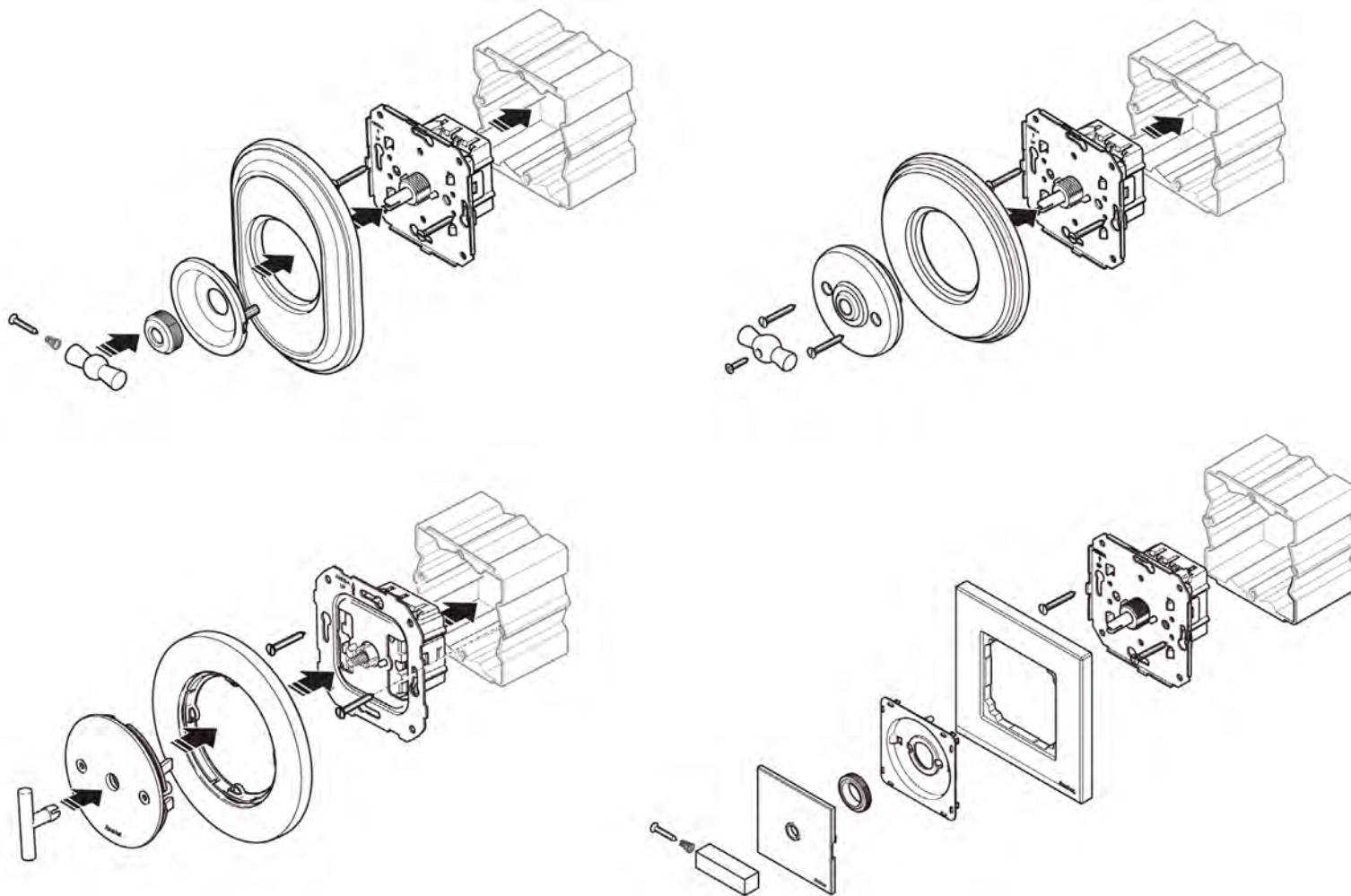

TOGGLE SWITCHES: VENEZIA / F37

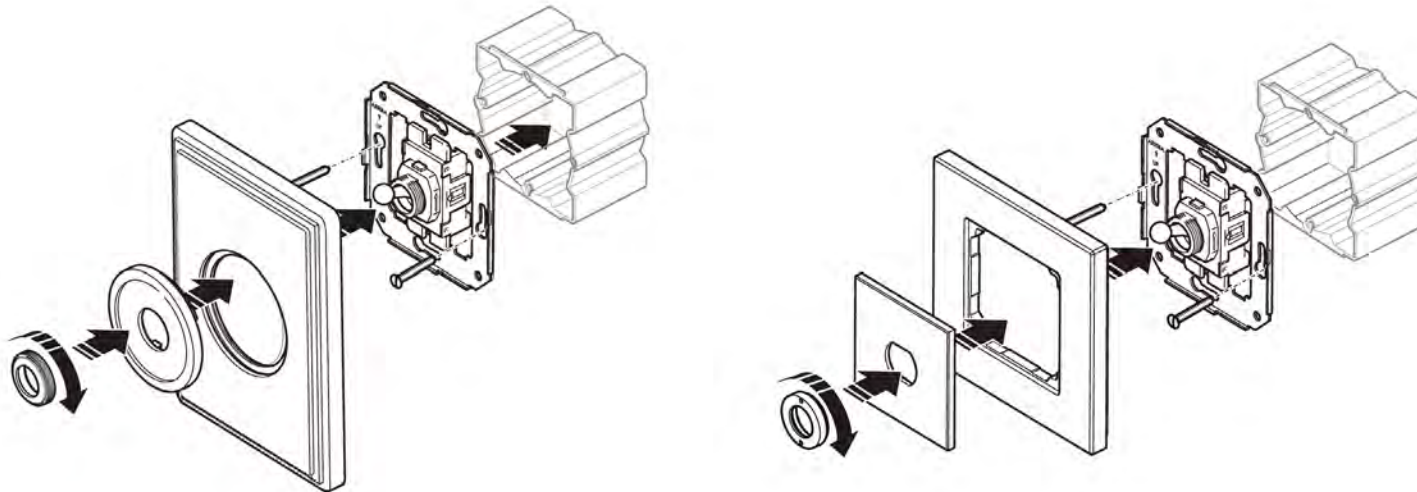

Esquemas de conexión / Connection schemes / Schémas de connexion

GARBY / GARBY COLONIAL / DO / VENEZIA / F37

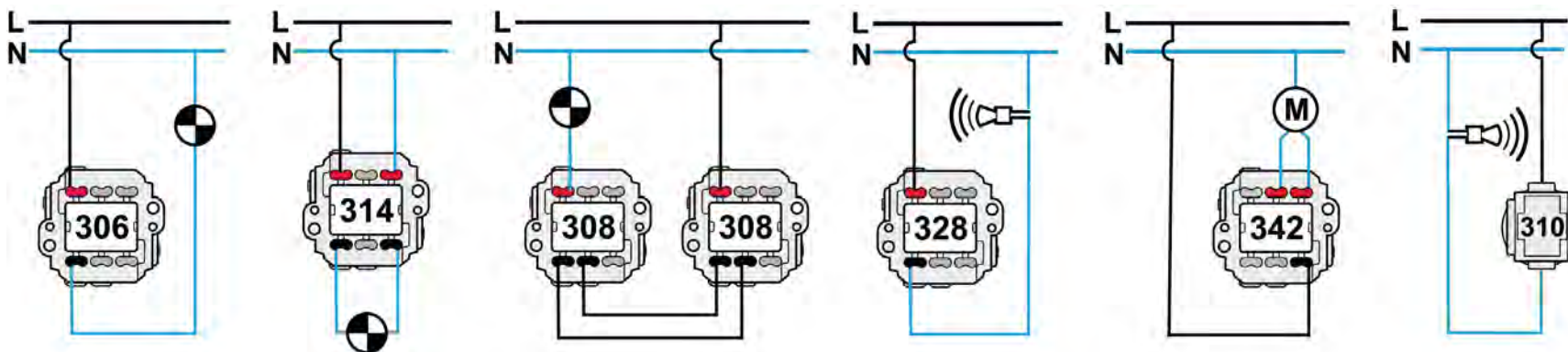

Interruptor
Switch
Interrupteur

Interruptor unipolar
Single pole switch
Interrupteur unipolaire

Conmutador
Two-way switch
Va-et-vient

Pulsador rotativo
Rotary pushbutton switch
Bouton rotatif

Mecanismo persianas
Electric blinds mechanism
Mécanisme volets roulants

Pulsador
Pushbutton
Bouton

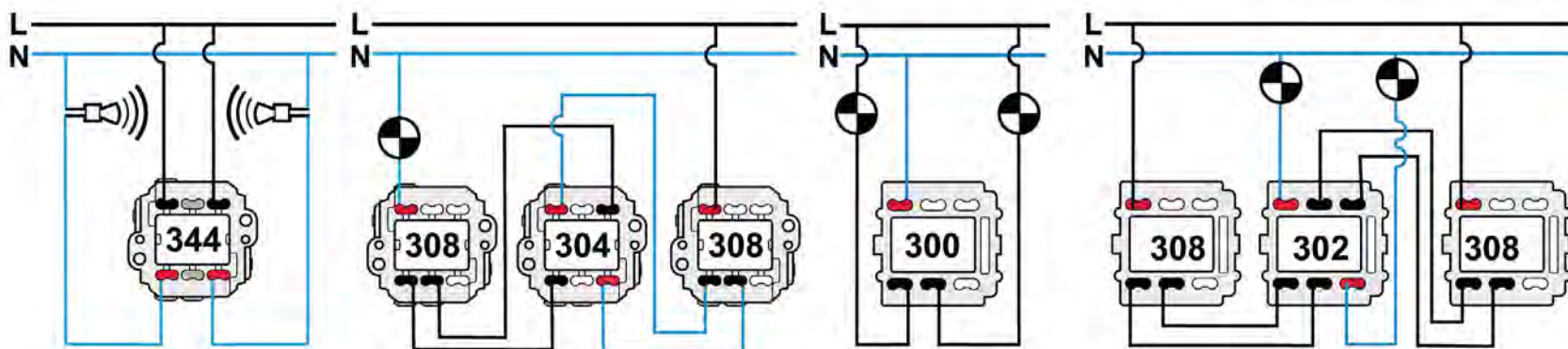

Doble pulsador rotativo
Double rotary pushbutton switch
Double bouton rotatif

Cruzamiento
Intermediate switch
Permutateur

Doble interruptor
Double one-pole switch
Double interrupteur unipolaire

Doble conmutador
Double two-way switch
Double va-et-vient

La colección Garby no dispone de las funciones Doble Interruptor y Doble Conmutador. Garby collection doesn't have Double switch and Double two-way switch mechanism.
La collection Garby ne dispose pas des fonctions Double Interrupteur et Double va-et-vient.

DIMBLER / TOGGLE SWITCHES: VENEZIA / F37

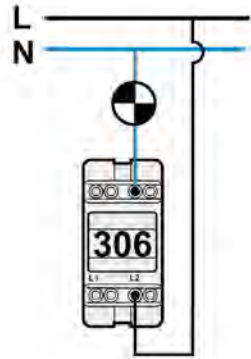

Interruptor
Switch
Interrupteur

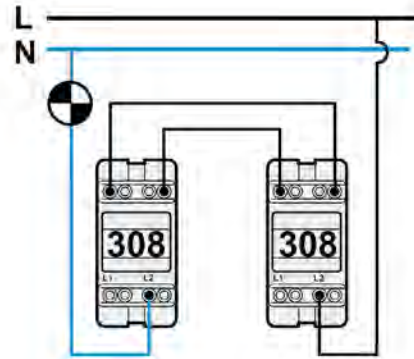

Conmutador
Two-way switch
Va-et-vient

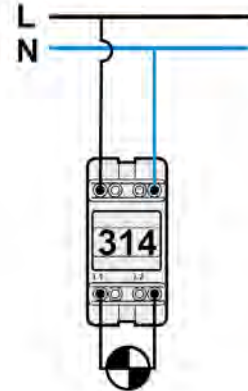

Interruptor bipolar
Double pole switch
Interrupteur bipolaire

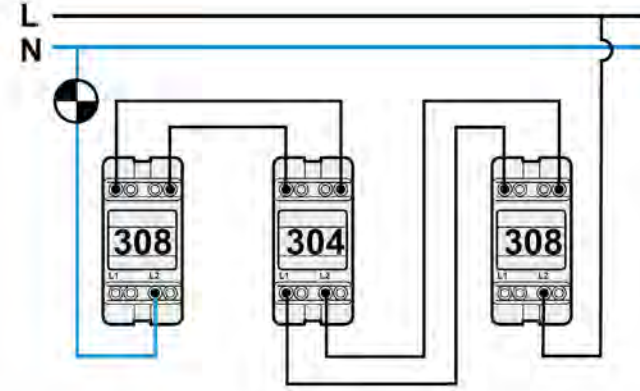

Cruzamiento
Intermediate switch
Permutateur

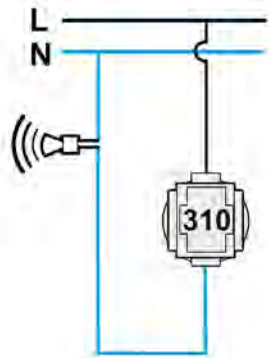

Pulsador
Pushbutton
Bouton

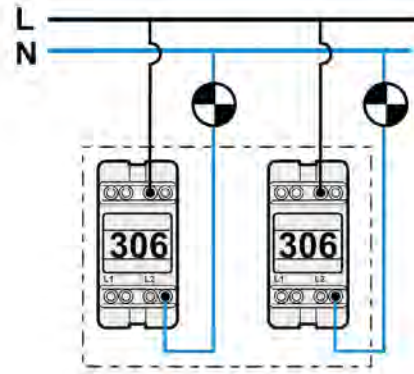

Doble interruptor
Double one-pole switch
Double interrupteur unipolaire

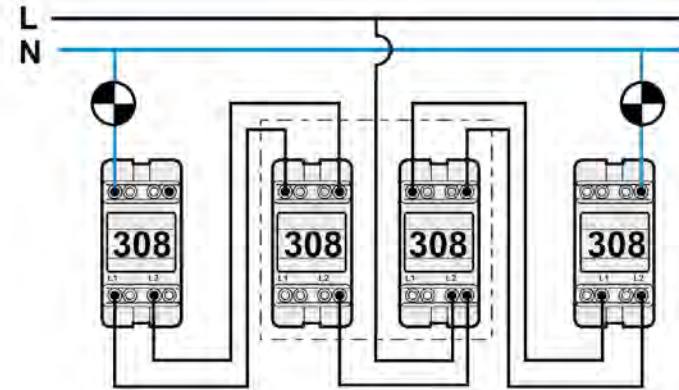

Doble conmutador
Double two-way switch
Double va-et-vient

Tarjetero hotel / Hotel key card / Porte-carte hôtel

Tensión nominal Rated voltage Tension nominale	125/250V ~
Corriente nominal Rated current Courant nominal	5(1)A y/and/et 2x 5(1)A
Dimensiones tarjeta Card dimensions Dimensions carte	5,4×8,6cm, ↔ 0,76mm según/according/ según ISO7816
Opciones Ceiling rose Options	Mecanismo con uno o dos microinterruptores Card switch with one or two microswitches Mécanisme avec un ou deux microinterrupteurs

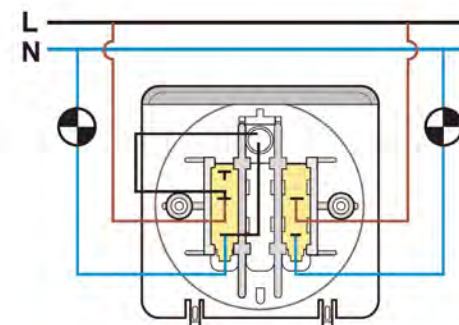
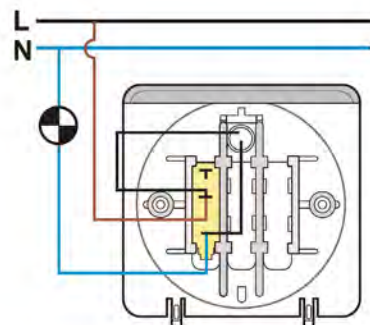

Detector de movimiento / Movement detector / Détecteur de mouvement

Tensión alimentación Power supply Tension d'alimentation	110-240VAC, 50/60Hz
Consumo Power consumption Consommation	aprox. 0,5 W
Ángulo de detección Area of coverage Angle de détection	semicircular 180° semi-circulaire 180°
Alcance Ø H 1,10m/T=18°C Ceiling rose Portée Ø H 1,10m/T=18°C	Transversal 10m / frontal 3m Tangential 10m / radial 3m Transversale 10m / frontale 3m
Altura de montaje máx. Max. mounting height Hauteur de montage max.	2,2m
Contacto Contact Contact	2300W, cosφ=1 1150VA, cosφ=0,5
Temporización Follow-up-time Temporisation	15 sec. to 16 min. or pulse
Valor de luminosidad Brightness threshold Valeur de luminosité	10 - 2000 Lux

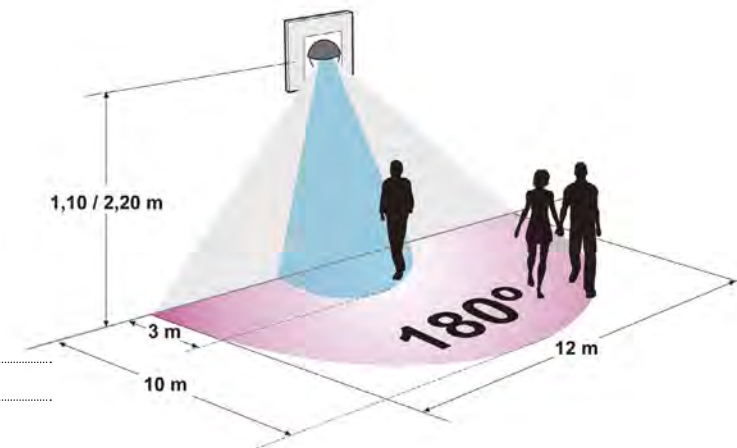
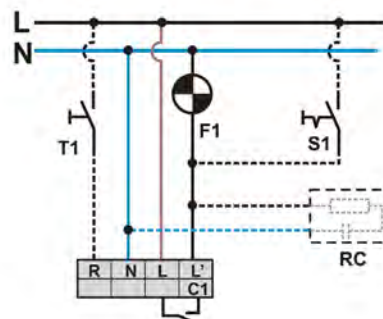

Opcionalmente / Optional / Optionnel

S1	Interruptor para luz permanente Switch for permanent light Interrupteur pour lumière permanente
T1	Pulsador con contacto NA; para conmutación manual adicional NO button, manual switching additionally possible Bouton avec contact NA; pour commutation manuelle additionnelle
RC	Elemento supresor RC en caso necesario RC - suppression kit if required Élément supresseur RC si nécessaire

Termostato / Thermostat / Thermostat

Indicador luminoso rojo Indicator lamp red Indicateur lumineux rouge	Demanda de calor Controller calls for heat Demande de chaleur	Sensor de temperatura Temperature sensor Détecteur de température	Interno Internal Interne
Indicador luminoso verde Indicator lamp green Indicateur lumineux vert	Reducción de consigna Set-back temperature Diminution de consigne	Reducción de consigna ambiente Temperature set-back Diminution de consigne ambiente	Seleccionable, 3K o 5K 3K or 5K selectable Sélectionnable, 3K ou 5K
Interruptor Power switch Interrupteur	Marcha-paro 2-pole Marche-arrêt	Limitador del rango Range limitation Limiteur de niveau	En el interior de la ruleta externa Inside the dial À l'intérieur de la roulette externe
Alimentación Supply voltage Alimentation	230V AC (195.253V) 50 Hz	Termostato ambiente Room temperature thermostat Thermostat ambiant	Rango de temperatura ambiente *...6 (5..30°C) Temp. setting range*...6 (5..30°C) Niveau de Température ambiante *...6 (5..30°C)
Salida Output Sortie	Relé Relay make contact Relais	Termostato suelo radiante Floor heating thermostat Thermostat sol radiant	Rango de temperatura del suelo*...5 (=10..50°C) Temp. setting range*...5 (=10..50°C) Niveau de température du sol*...5 (=10..50°C)
Intensidad permanente Switching current Intensité permanente	100mA...16 A cosφ=1	Características de la sonda / Sensor characteristics / Caractéristiques de la sonde	
Diferencial de temperatura Switching temperature differential Différentiel de température	-0,5 °C	10°C	20°C
		66,8 kΩ	41,3 kΩ
		30°C	40°C
		26,3 kΩ	17 kΩ

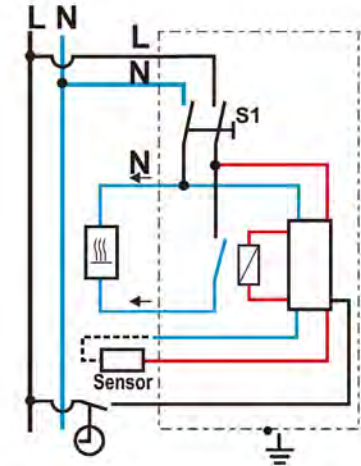

Cargador USB / USB charging socket / Chargeur USB

2 puertos USB tipo A
2 USB ports type A
2 ports USB type A

Tensión de entrada Supply voltage Tension d'entrée	AC 100...240V~, 50/60 Hz
Tensión de salida Output voltage Tension de sortie	DC 5V
Corriente de salida Output current Courant de sortie	2600 mA
Potencia absorbida sin carga a $U_E=230V\sim$ Power absorbed without load at $U_E=230V\sim$ Puissance absorbée sans chargement à $U_E=230V\sim$	≤ 0,15 W
Conexión Assembly Connexion	Bornes de tornillo Screws terminals Bornier à vis
Área de la sección transversal máx. Maximum cross section Zone de la section transversale max.	1 x 2,5 mm ² ó 2 x 1,5 mm ²

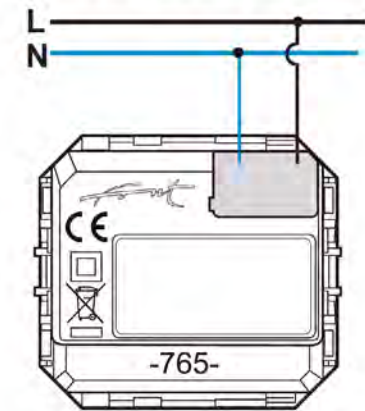

Tomas de televisión / Television aerial socket / Prises de télévision

Máximo número de tomas: 8 (dependiendo de la potencia de la señal de entrada).

Maximum number of sockets: 8 (depending on the entering signal power).

Nombre maximum de prises : 8 (en fonction de la puissance du signal d'entrée).

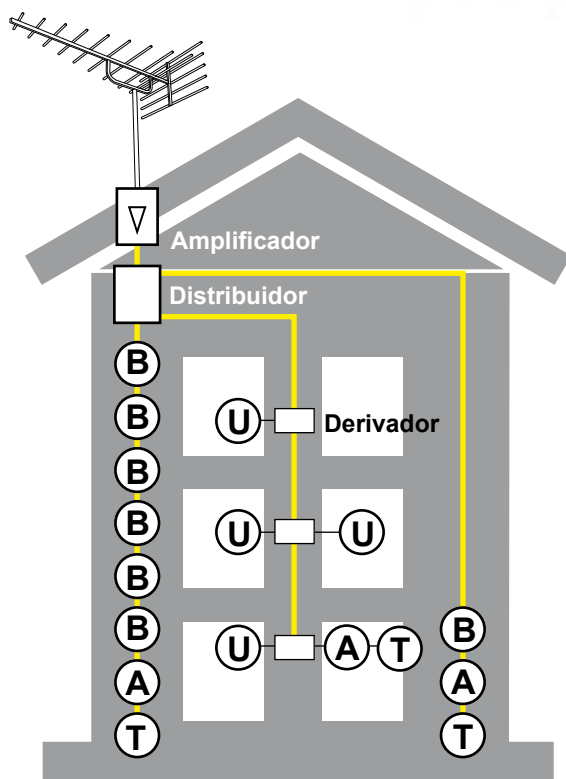
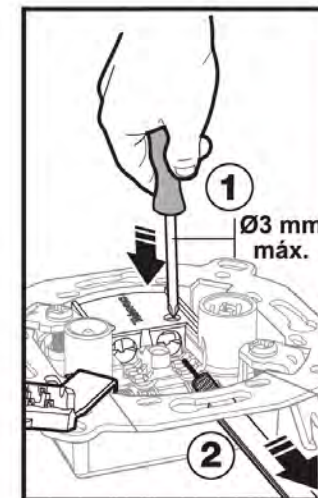
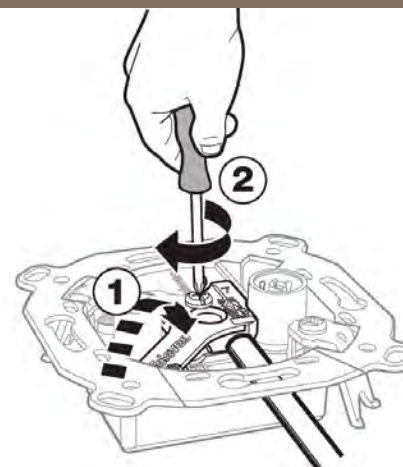
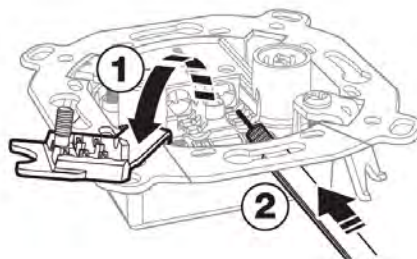
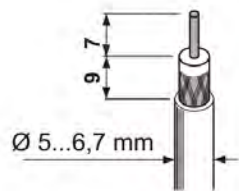

	Pérdidas inserción typ (dB) Insertion losses typ (dB) Pertes insertion type (dB)		OUT	Pérdidas derivación typ (dB) Derivation losses typ (dB) Pertes dérivation typ (dB)		Paso DC DC pass Passage DC
	MATV	SAT-FI		MATV	SAT-FI	
	5-862 MHz	950-2150 MHz		5-862 MHz	950-2150 MHz	
Toma única Single socket Prise unique	---	---	R/TV	0,6	---	
			SAT	---	1,5	
Toma intermedia Intermediate socket Prise intermédiaire	1,2	2	R/TV	13	13,5	
			SAT	13	14	
Toma intermedia Intermediate socket Prise intermédiaire	3,5	5	R/TV	8,5	9	
			SAT	7,5	10	
Toma final Final socket Prise finale	---	---	R/TV	4	5	
			SAT	4	5	

Toma de telefonía RJ11/ Telephone socket RJ11 / Prise de téléphone RJ11

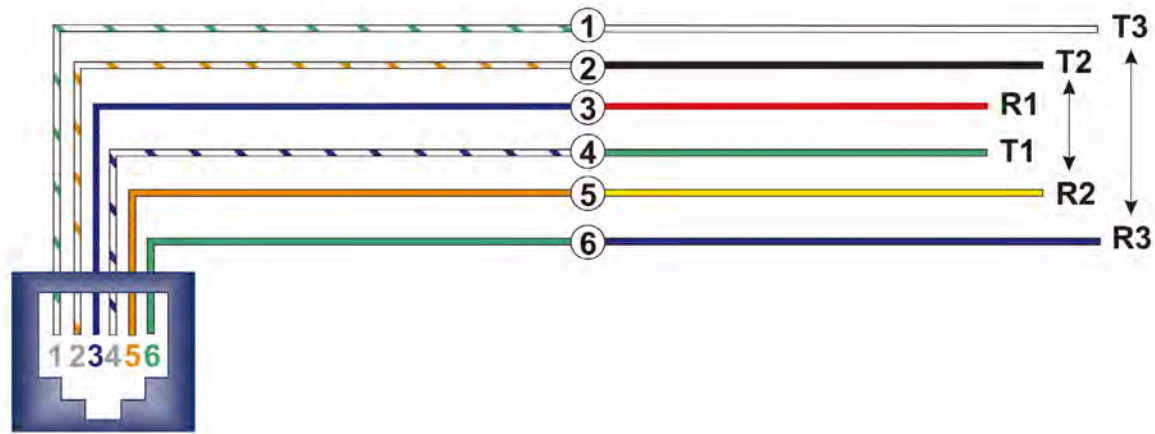

Un par de cables (R1-T1, normalmente rojo-verde o blanco- marrón) irán conectados a los bornes azul y blanco-azul.

A twisted pair (R1-T1, normally red-green or white-brown) will be connected to blue and white-blue terminals.

Une paire de câbles (R1-T1, normalement rouge-vert ou blanc-marron) sera branchée aux bornes bleues et blanc-bleu.

Toma de datos RJ45 / Data socket RJ45 / Prise de données RJ45

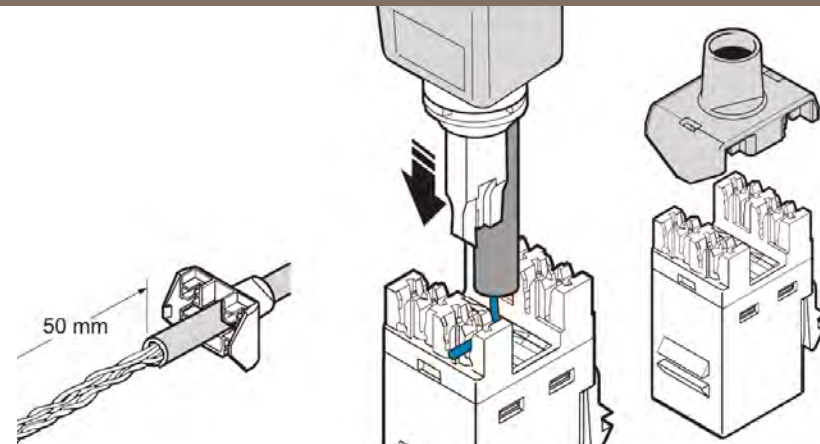
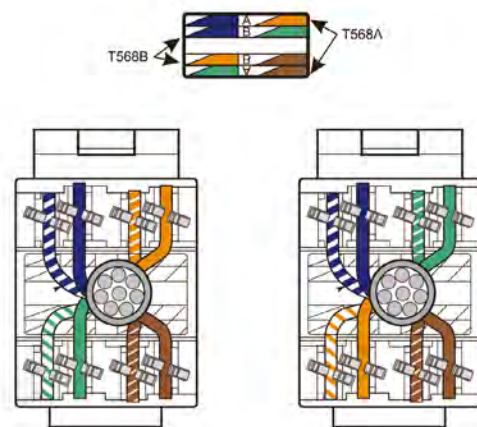

Regulador rotativo / Rotary dimmer / Variateur rotatif

GARBY COLONIAL / VENEZIA / F37 (3X-332)

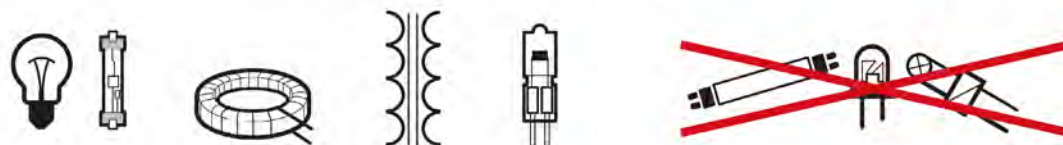
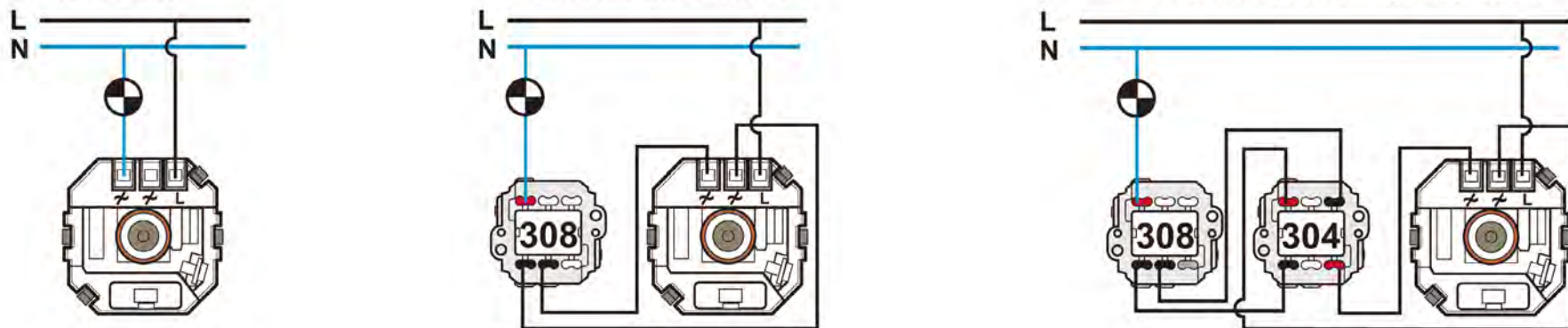

Especificaciones técnicas / Technical specifications / Spécifications techniques

Rango de voltaje
Rated voltage
Niveau de voltage

230 V ~ 50 Hz

Protegido frente a sobretensiones con un fusible de 2.5 A.
Protected against overload with a fuse of 2.5 A.
Protégé en cas de surtensions avec un fusible

Tipos de lámpara / Rated a / Types de lampe

Incandescentes y halógenas (GU10, G9 y lámparas similares) de 60 a 500 W.
Incandescent and halogen bulbs (GU10, G9 and similar lamps) from 60 to 500 W.
Incandescentes et halogènes (GU10, G9 et lampes similaires) de 60 à 500 W.

Transformador toroidal de 60 a 500 W.
Toroidal transformers from 60 to 500 W.
Transformateur toroïdal de 60 à 500 W.

Transformador electromecánico de 90 a 500 W.
Electromechanical transformers from 90 to 500 W.
Transformateur électromécanique de 90 à 500 W.

Estos reguladores no son válidos para transformadores electrónicos regulables, lámparas de bajo consumo, tubos fluorescentes o ventiladores.

Do not use for electronic dimmable transformers, energy saving bulb, fluorescent tubes or fans.

Ces variateurs ne sont pas adaptés aux transformateurs électroniques réglables, lampes à basse consommation, tubes fluorescents ou aux ventilateurs.

Regulador rotativo / Rotary dimmer / Variateur rotatif

DO empotrar (34-332)

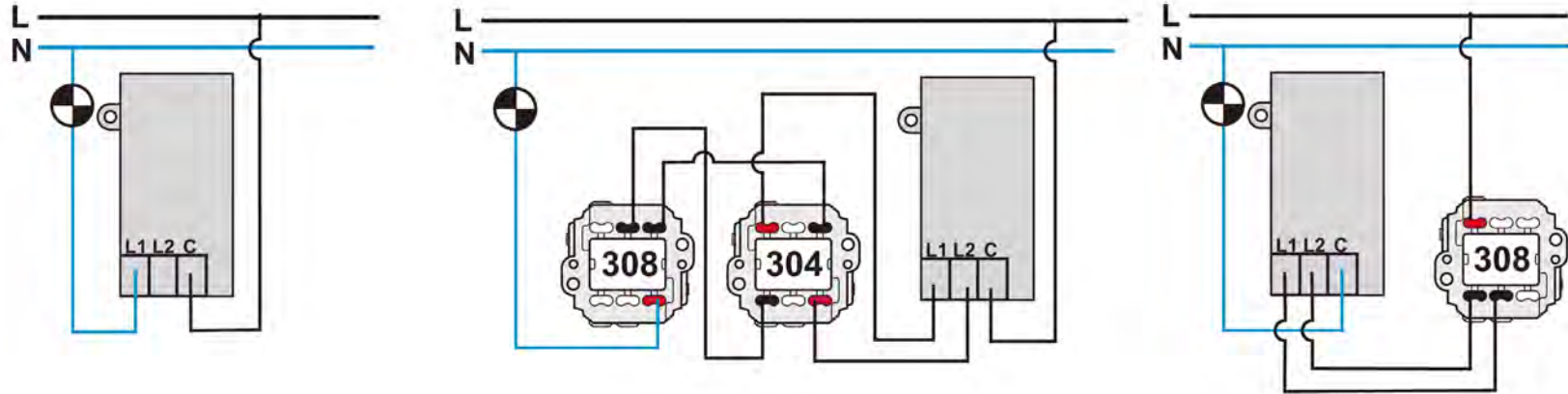

Especificaciones técnicas / Technical specifications / Spécifications techniques

Rango de voltaje
Rated voltage
Niveau de voltage

230 V ~ 50 Hz

Protección automática contra sobrecargas
Protected against overload
Protection automatique contre les surcharges

Un solo regulador por circuito
Only one dimmer per circuit
Un seul variateur par circuit

Tipos de lámpara / Rated a / Types de lampe

Incandescentes y halógenas (GU10, G9 y lámparas similares)
Incandescent and halogen bulbs (GU10, G9 and similar lamps)
Incandescentes et halogènes (GU10, G9 et lampes similaires)

Transformador electrónico (máximo 5 transformadores por regulador)
Electronic transformer (maximum 5 per dimmer)
Transformateur électronique (maximum 5 transformateurs par régulateur)

© 2018 Fontini S.A.

Supervisión técnica: Roger Font / Justin Esturo

Creación y diseño: Q-ART, comunicació i disseny, sl.

Los colores de los productos fotografiados en este catálogo están sujetos a los cambios de tonalidades propios de los materiales naturales con que están fabricados, así como a las desviaciones cromáticas de la reproducción impresa.

Todas las referencias, códigos y medidas son válidos salvo error tipográfico.

Fontini S.A. se reserva el derecho a modificar el contenido de este catálogo sin previo aviso.

Fontini

BY

Font
BARCELONA

Pol. Ind. Can Bernades-Subirà, C/ Anòia, 15 - 08130 Santa Perpètua de Mogoda (Barcelona) Spain
Tel. +34 93 574 33 30 / Fax +34 93 574 21 19 / info@fontini.com / www.fontini.com